



# V-PLUS

Prodotto per uso strutturale in accordo al D.M. 14/01/2008



Opzione > Option 1

M10 ... M20

Opzione > Option 7  
M8 ... M24



Ø 8 ... 32 mm

**FIXING IN SEISMIC**

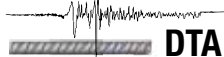

**DTA**

since 2016



COMMISSION CHARGÉE  
DE FORMULER  
LES AVIS TECHNIQUES  
**CSTB**



## BCR-825(\*) V-PLUS

Cartuccia shuttle  
Shuttle cartridge  
Cartouche Shuttle  
Shuttlekartusche  
825 ml  
cod. 747285



## BCR-400 V-PLUS

Cartuccia coassiale  
Coaxial cartridge  
Cartouche coaxial  
Koaxialkartusche  
400 ml  
cod. 747280



## BCR-345 V-PLUS

Cartuccia shuttle  
Shuttle cartridge  
Cartouche Shuttle  
Shuttlekartusche  
345 ml  
cod. 747270



## BCR-300 V-PLUS

Cartuccia sacchetto  
Foil cartridge  
Cartouche avec sachet  
Schlauchfolienkartusche  
300 ml  
cod. 747260



## BCR-165 V-PLUS

Cartuccia sacchetto  
Foil cartridge  
Cartouche avec sachet  
Schlauchfolienkartusche  
165 ml  
cod. 747250



(\*) Su richiesta > On demand > Sur demande > Auf Wunsch



**STOCCAGGIO E CONSERVAZIONE**  
**STORAGE AND CONSERVATION**  
**STOCKAGE ET CONSERVATION**  
**LAGERUNG UND AUFBEWAHRUNG**



**CARTUCCIA**  
**CARTRIDGE**  
**CARTOUCHE**  
**KARTUSCHE**



**DURATA (mesi)**  
**EXPIRY (months)**  
**ECHEANCE (mois)**  
**HALTBARKEIT (Monate)**



# SCHEDA TECNICA TECHNICAL DATA SHEET FICHE TECHNIQUE TECHNISCHES DATENBLATT

sistemi di fissaggio  
**BOSSONG**<sup>®</sup>  
www.bossong.com

**V-PLUS**  
 > CARATTERISTICHE > CHARACTERISTICS  
 > CARACTÉRISTIQUES > EIGENSCHAFTEN



Resina Vinilestere senza stirene  
Vinylester resin styrenfree  
Résine Vinylester sans styrène  
Vinylesterharz Styrolfrei



Dichiarazione di Prestazione su  
Declarations of Performance on  
[www.bossong.com](http://www.bossong.com)



ETA (European Technical Assessment) aggiornati in accordo al nuovo regolamento prodotti da costruzione nr. 305/2011. DoP Dichiarazione di prestazione disponibile sul nostro sito [www.bossong.com](http://www.bossong.com).

In base ai dati di carico CE-ETA avete a disposizione uno dei migliori prodotti presenti sul mercato europeo con doppia certificazione.

ETA-09/0140 Opzione 7 da M8 a M24 per calcestruzzo non fessurato e **OPZIONE 1 PER INSTALLAZIONE IN CALCESTRUZZO FESSURATO** con barre da M10 a M20. Il prodotto è omologato per fissaggi con profondità variabile di ancoraggio, per dare al progettista un'elevata flessibilità. Massima profondità di ancoraggio fino a venti volte il diametro nominale della barra filettata. ETA-09/0246 Barre ad aderenza migliorata (diametro da 8mm a 32mm) per connessioni post-installate in calcestruzzo armato. Riduzione della minima profondità di ancoraggio per la realizzazione di connessioni post-installate di barre ad aderenza migliorata. Rapporto di valutazione per la resistenza al fuoco.

Versione Jumbo da 825 ml omologata, ideale per grandi lavori.

Possibilità di utilizzo del prodotto in calcestruzzo asciutto, umido e foro allagato (foro allagato qualificato solo per barre filettate). La reazione di indurimento del prodotto avviene anche in presenza di acqua.

Le temperature di esercizio certificate sono negli intervalli:

- 40°C/+40°C (T° max lungo periodo = 24°C)
- 40°C/+80°C (T° max lungo periodo = 50°C)
- 40°C/+120°C (T° max lungo periodo = 72°C)

Tempi di attesa ridotti per la messa in carico con temperature del supporto che vanno da un minimo di -10°C fino a +40°C.

Qualifica VOC in accordo al Decreto francese nr. 2011-321 ed in conformità alla Norma ISO 16000.



ETA (European Technical Assessments) updated according to the new Construction Product Regulation 305/2011. DoP Declarations of Performance available on our website [www.bossong.com](http://www.bossong.com).

According to CE-ETA load data, it is one of the best vinylester resins in the European market with double approval.

ETA-09/0140 Option 7 from M8 to M24 for non-cracked concrete and **OPTION 1 FOR INSTALLATION IN CRACKED CONCRETE** with rods from M10 to M20. It is certified for fixing with variable anchorage depths. This means that the project engineer has with this product a considerable flexibility in the design phase. Maximum embedment depth up to 20 times nominal threaded rod diameter.

ETA-09/0246 Rebar (diameter from 8mm to 32mm) for post installed rebar connections in reinforced concrete.

Reduction of minimum embedment depth for the realization of post installed rebar connections. Fire resistance evaluation report.

Approved 825 ml Jumbo version, ideal for large jobs.

Possibility of using the product in dry and wet concrete and flooded hole (the latter approved only for threaded rods). The product hardening reaction takes place even in presence of water.

Certified service temperatures are in the ranges:

- 40°C/+40°C (T° max long period = 24°C)
- 40°C/+80°C (T° max long period = 50°C)
- 40°C/+120°C (T° max long period = 72°C)

Reduced curing time for base material temperatures from -10°C to +40°C.

VOC according to the French Decree nr. 2011-321 and the Norm ISO 16000.



ETA (Évaluations techniques européennes) mises à jour selon le nouveau Règlement sur les Produit de Construction nr. 305/2011. DoP Déclaration de Performances disponible sur notre site [www.bossong.com](http://www.bossong.com)

Vous avez à disposition un des meilleurs produits sur le marché européen pour des données de charge avec double ATE. ETA-09/0140 Option 7 de M8 à M24 pour béton non fissuré et **OPTION 1 POUR INSTALLATION EN BÉTON FISSURÉ** avec des barres de M10 à M20. Le produit est homologué pour fixations avec variables profondeurs d'ancrage, pour donner à l'ingénieur une haute flexibilité pendant la phase de projet. Profondeur d'ancrage maximale jusqu'à vingt fois le diamètre nominal de la tige filettée.

ETA-09/0246 Fers à béton (diamètre de 8mm à 32mm) pour scellement d'armatures rapportées en béton armé.

Réduction de la profondeur d'ancrage minimum pour la réalisation de scellements d'armatures rapportées avec des fers à béton. Rapport d'évaluation de résistance au feu.

Version Jumbo 825 ml homologuée, idéale pour les gros travaux.

Possibilité d'utilisation du produit en béton sec, humide et trou inondé (ce dernier qualifié seulement pour tige filettées). La réaction de durcissement du produit se produit même en présence d'eau.

Les températures de travail certifiées sont entre les intervalles:

- 40°C/+40°C (T° max longue période = 24°C)
- 40°C/+80°C (T° max longue période = 50°C)
- 40°C/+120°C (T° max longue période = 72°C)

Temps de durcissement total (avant l'application de la charge) réduit avec températures du support à partir d'un minimum de -10°C jusqu'à +40°C.

Qualification COV selon le Décret français nr. 2011-321 et en conformité avec la Norme ISO 16000.

**FIXING IN SEISMIC**

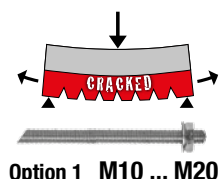
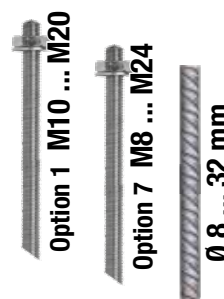
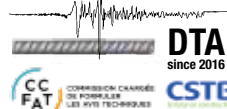

VTE Valutazione Tecnica Europea  
Opzione 7 per calcestruzzo non fessurato.  
Opzione 1 per calcestruzzo fessurato.  
ETA European Technical Assessment  
Option 7 non cracked concrete.  
Option 1 cracked concrete.

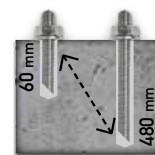

Applicazioni con profondità variabile di ancoraggio  
Use with variable anchorage depth  
Applications avec variables profondeurs d'ancrage  
Anwendungen mit variable Verankerungstiefen



Presenza d'acqua: calcestruzzo umido e foro allagato  
Water in place: wet concrete and flooded hole use  
Eau sur place: béton humide et forage/trou inondé  
Dieses Harz darf sowohl in nassem Beton als auch in mit Wasser gefüllten Bohrlöchern verwendet werden

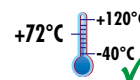
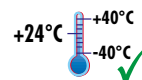

Di esercizio  
Service range





ETA (Europäische Technischen Bewertungen) aktualisiert nach der neuen Bauproduktregulierung Nr. 305/2011. DoP Erklärung der Leistung auf der Website [www.bossong.com](http://www.bossong.com) Nach den CE-ETA Lastdaten ist V-PLUS einer der besten Vinylesterharze auf dem europäischen Markt mit doppelter Zulassung.

ETA-09/0140 Option 7 von M8 bis M24 für ungerissenen Beton und **OPTION 1 FÜR DEN EINBAU IN GERISSENEM BETON** mit Gewindestangen von M10 bis M20. V-PLUS hat laut CE-ETA variable Verankerungstiefen. So ist der Anwender in hohem Maße flexibel! Maximale Setztiefe bis Zwanzigfache der Durchmesser des Gewindestabes.

ETA-09/0246 Bewehrungsseisen (Durchmesser von 8 mm bis zu 32 mm) für nachträglich eingemörtelte Bewehrungsanschlüsse in Stahlbeton. Reduzierung der minimalen Setztiefe für die Realisierung der Bewehrungsanschlüsse. Prüfungsberichts des Feuerwiderstandes.

Zugelassene 825 ml Jumbo-Kartusche, ideal für großartige Arbeit. Anwendung des Produktes möglich in trockenem Beton, nassem Beton und mit Wasser gefüllten Bohrlöcher (Anwendung mit Wasser gefüllten Bohrlöcher zugelassen nur mit Gewindestäbe). Die Aushärtungsreaktion des Produktes findet auch in Gegenwart von Wasser statt.

Die zugelassene Temperaturbeständigkeit nach Aushärtung liegt zwischen:

-40°C/+40°C (langfristig max. = 24°C)

-40°C/+80°C (langfristig max. = 50°C)

-40°C/+120°C (langfristig max. = 72°C).

Reduzierte Bauzeit mit Temperaturen des Grundmaterials von -10°C bis zu +40°C.

VOC-Qualifizierung nach dem französischen Dekret Nr. 2011-321 und nach der Norm ISO 16000.



**V-PLUS REBAR DESIGN**

Su richiesta > On demand  
Sur demande > Auf Wunsch



Progettazione secondo Eurocode 2 (EC2)  
Project according to Eurocode 2 (EC2)  
Conception selon Eurocode 2 (EC2)  
Projekt nach Eurocode 2 (EC2)

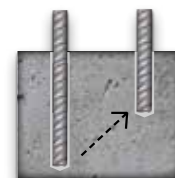

Reduzione profondità minima Rebar  
Reduction of minimum embedment depth for rebar  
Réduction de la profondeur d'ancrage minimum pour fers à béton.  
Reduzierung der minimalen Setztiefe mit Bewehrungsseisen.



**TEMPI DI POSA**  
**SETTING TIMES**  
**TEMPS D'INSTALLATION**  
**VERLEGUNGSZEIT**

°C	01	02	03
40 °C	1 min	20 min	
35 °C	2 min	25 min	
30 °C	3 min	30 min	
25 °C	5 min	35 min	
20 °C	7' 30"	40 min	
15 °C	11' 30"	45 min	
10 °C	16 min	1 hour	
5 °C	25 min	1 h 30'	
0 °C	45 min	7 hours	
-5 °C	65 min	13 hours	
-10 °C	1 h 45'	22 hours	

**ASCIUTTO**  
**DRY**  
**SEC**  
**TROCKENEM**

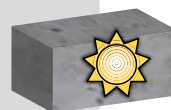

**FAST CURING TIME**



**TEMPI DI POSA**  
**SETTING TIMES**  
**TEMPS D'INSTALLATION**  
**VERLEGUNGSZEIT**

°C	01	02	03
40 °C	1 min	40 min	
35 °C	2 min	50 min	
30 °C	3 min	1 hour	
25 °C	5 min	1 h 10'	
20 °C	7' 30"	1 h 20'	
15 °C	11' 30"	1 h 30'	
10 °C	16 min	2 hours	
5 °C	25 min	3 hours	
0 °C	45 min	14 hours	
-5 °C	65 min	26 hours	
-10 °C	1 h 45'	44 hours	

**UMIDO / FORO ALLAGATO**  
**WET / FLOODED HOLE**  
**HUMIDE / TROU INONDÉ**  
**NASSEM / WASSER GEFÜLLTEN**  
**BOHRLÖCHER**

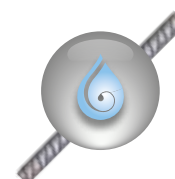
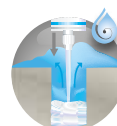
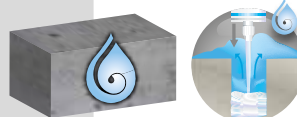

Presenza d'acqua: calcestruzzo umido  
Water in place: wet concrete  
Eau sur place: béton humide  
Wasser in Platz: dieses Harz darf auch in nassem Beton verwendet werden

- 01 Temperatura supporto > Base material temperature > Temperature material de base > Grundmaterial-temperatur
- 02 Tempo di lavorabilità > Open time > Temps de manipulation > Verarbeitungszeit
- 03 Attesa per la messa in carico > Curing time > Temps avant l'application de charge > Bauzeit

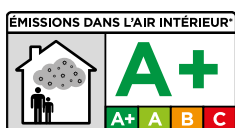

\*Information sur le niveau d'émission de substances volatiles dans l'air intérieur, présentant un risque de toxicité par inhalation, sur une échelle de classes allant de A+ (très faibles émissions) à C (fortes émissions)



CARTUCCIA > CARTRIDGE  
CARTOUCHE > KARTUSCHE  
**300 - 165 ml:**  
Sistema di apertura sacchetto  
Plastic foil opening system  
Plastic foil opening system  
Plastic foil opening system



# SCHEDA TECNICA TECHNICAL DATA SHEET FICHE TECHNIQUE TECHNISCHES DATENBLATT

## > Applicazioni > Applications > Applications > Anwendungen



Edilizia Civile Pesante  
Heavy Building Construction  
Construction Civile Lourde  
Schwerlasten im  
Zivilbauwesen



Edilizia Industriale Pesante  
Heavy Industrial Construction  
Construction industrielle lourde  
Schwerlasten im  
Industriebauwesen



Settore Elettrico Pesante  
Heavy Electricity Area  
Secteur Electricite Lourde  
Schwerlasten im  
Elektrobauges



Settore Idraulico e Lattineria pesante  
Heavy Hydraulic and Tiling Area  
Secteur lourd Hydraulique et Ferblanterie  
Schwerlasten im Hydraulikwesen  
und Blecharbeiten

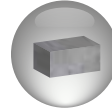

Calcestruzzo  
Concrete  
Béton  
Beton

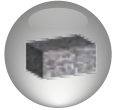

Pietra  
Stone  
Pierre  
Stein



Mattone pieno  
Solid Brick  
Brique pleine  
Vollmauerwerk



Mattone semipieno  
Not Solid Brick  
Brique demi-pleine  
Semivollmauerwerk

















Mattone forato  
Hollow Brick  
Brique creux  
Lochziegel



Legno  
Wood  
Bois  
Holz

## > Gamma prodotti > Product's range > Gamme produits > Warenangebot

	CODICE > CODE NUMBER	ARTICOLO > ITEM TYPE > ARTIKEL	DESCRIZIONE > DESCRIPTION DESCRIPTION > BESCHREIBUNG	 Nr.
	747245	<b>TERMO 165 V-PLUS</b>	Confezionamento con foglio termico > Thermo foil packed Emballage avec feuil thermique > Thermo- Folienverpackung	12
	747014	<b>KIT 300 V-PLUS</b>	2 x cartridges, 1 x gun, 4 x mixers, 1x brush, 1 x air pump, 10 x studs M8, 10 x studs M10, 10 x sleeves GC 12x80, 10 x sleeves GC 15x85	1
	747015	<b>KIT 345 V-PLUS</b>	2 x cartridges, 1 x gun, 4 x mixers, 1x brush, 1 x air pump, 10 x studs M8, 10 x studs M10, 10 x sleeves GC 12x80, 10 x sleeves GC 15x85	1
	747016	<b>KIT 400 V-PLUS</b>	2 x cartridges, 1 x gun, 4 x mixers, 1x brush, 1 x air pump, 10 x studs M8, 10 x studs M10, 10 x sleeves GC 12x80, 10 x sleeves GC 15x85	1
	747302	<b>OSR 400 V-PLUS SECCHIO</b>	12 cartucce, 1 pistola, 24 mixer > 12 x cartridges, 1 x gun, 24 x mixers 12 x cartouches, 1 x pompe, 24 x mixers 12 x Kartuschen, 1 x Auspresspistole, 24 x Mischer	1
	747301	<b>OSR 345 V-PLUS SECCHIO</b>	15 cartucce, 1 pistola, 30 mixer > 15 x cartridges, 1 x gun, 30 x mixers 15 x cartouches, 1 x pompe, 30 x mixers 15 x Kartuschen, 1 x Auspresspistole, 30 x Mischer	1
	747300	<b>OSR 300 V-PLUS SECCHIO</b>	18 cartucce, 1 pistola, 36 mixer > 18 x cartridges, 1 x gun, 36 x mixers 18 x cartouches, 1 x pompe, 36 x mixers 18 x Kartuschen, 1 x Auspresspistole, 36 x Mischer	1
	747305	<b>OSR 400 V-PLUS SECCHIO NP-2M</b>	12 cartucce, 24 mixer > 12 x cartridges, 24 x mixers 12 x cartouches, 24 x mixers > 12 x Kartuschen, 24 x Mischer	1
	747304	<b>OSR 345 V-PLUS SECCHIO NP-2M</b>	15 cartucce, 30 mixer > 15 x cartridges, 30 x mixers 15 x cartouches, 30 x mixers > 15 x Kartuschen, 30 x Mischer	1
	747303	<b>OSR 300 V-PLUS SECCHIO NP-2M</b>	18 cartucce, 36 mixer > 18 x cartridges, 36 x mixers 18 x cartouches, 36 x mixers > 18 x Kartuschen, 36 x Mischer	1
	747310	<b>BOX 400 V-PLUS</b>	20 cartucce, 40 mixer > 20 x cartridges, 40 x mixers 20 x cartouches, 40 x mixers > 20 x Kartuschen, 40 x Mischer	1
	747309	<b>BOX 345 V-PLUS</b>	25 cartucce, 50 mixer > 25 x cartridges, 50 x mixers 25 x cartouches, 50 x mixers > 25 x Kartuschen, 50 x Mischer	1
	747308	<b>BOX 300 V-PLUS</b>	30 cartucce, 60 mixer > 30 x cartridges, 60 x mixers 30 x cartouches, 60 x mixers > 30 x Kartuschen, 60 x Mischer	1

CARTUCCIA + MIXER > CARTRIDGE + MIXER  
CARTOUCHER + MIXER > KARTUSCHE + MIXER  
CARTUCCIA + MIXER > CARTRIDGE + MIXER  
CARTOUCHER + MIXER > KARTUSCHE + MIXER





> **Numero fissaggi > Number of fixings > Nombre de fixations > Anzahl der Befestigungen**

Fissaggi nei materiali pieni > Fixings in solid materials > Fixations dans matériaux pleins > Befestigungen in Vollsteinen



BARRA FILETTATA > THREADED STUD BARRE FILETÉE > GEWINDESTANGE	FORO > HOLE TROU > BOHRLOCH	BCR 165	BCR 300	BCR 345	BCR 400	BCR 825
	d <sub>o</sub> [mm] x h <sub>1</sub> [mm]	Nr. Fissaggi > Fixings	Nr. Fissaggi > Fixings	Nr. Fissaggi > Fixings	Nr. Fissaggi > Fixings	Nr. Fissaggi > Fixings
 M 8	10 x 90	± 30	± 54	± 61	± 72	± 147
M 10	12 x 95	± 21	± 39	± 44	± 52	± 106
M 12	14 x 115	± 14	± 25	± 30	± 34	± 70
M 16	18 x 130	± 9	± 16	± 18	± 21	± 43
M 20	24 x 175	± 3	± 6	± 6,5	± 7	± 15
M 24	28 x 215	± 2	± 4	± 4,5	± 5	± 10

Fissaggi nei materiali forati > Fixings in hollow materials > Fixations dans matériaux creux > Befestigungen in lochsteine



BARRA FILETTATA > THREADED STUD BARRE FILETÉE > GEWINDESTANGE	BCR 165	BCR 300	BCR 345	BCR 400	BCR 825	GABBIETTA > SLEEVE TAMIS > HÜLSE
d <sub>nom</sub> [mm]	Nr. Fissaggi > Fixings	Nr. Fissaggi > Fixings	Nr. Fissaggi > Fixings	Nr. Fissaggi > Fixings	Nr. Fissaggi > Fixings	d <sub>nom</sub> [mm] x L [mm]
 M 8	± 9	± 16	± 18	± 21	± 44	GC 15 x 85
M 10	± 9	± 16	± 18	± 21	± 44	GC 15 x 85
M 12	± 9	± 16	± 18	± 21	± 44	GC 15 x 85
M 16	± 5	± 9	± 10	± 12	± 25	GC 20 x 85

- > **NOTA:** Il numero di fissaggi sopra specificato è stato determinato conteggiando esclusivamente il volume teorico di prodotto necessario al riempimento del foro (o gabbietta) escluso il volume della barra inserita. Pur essendo incluso nel calcolo teorico uno spreco standard, il reale quantitativo di prodotto potrà differire da questo in funzione della effettiva modalità di posa in opera adottata.
- > **WARNING:** The number of fixings above mentioned has been calculated according to the theoretical volume needed to fill the hole (or sleeve) excluded the volume of the inserted metal rod. In the theoretical volume it is included a standard extra quantity but the real quantity of the product may be different than it in function of the real application of the product.
- > **NOTE:** Le numéro des fixations sur mentionné a été déterminé en calculant exclusivement le volume théorique de produit nécessaire au remplissage du trou (ou tamis), exclu le volume de la tige filetée. Bien si dans le calcul théorique est incluse une quantité standard de matériel extra, la quantité réelle de produit peut être différente, en fonction des effectives modes d'application du produit.
- > **ANMERKUNG:** Die obengenannte Anzahl der Befestigungen wurde nach dem theoretischen Volumen für die Bohrlochfüllung (oder Siebhülse-Füllung) minus dem Volumen der Gewindestange berechnet. Im theoretischen Volumen wird eine Standard-Extra-Menge einkalkuliert, aber die wirkliche Produktmenge kann anders sein, abhängig von der wirklichen Anwendung des Produktes.





# SCHEDA TECNICA TECHNICAL DATA SHEET FICHE TECHNIQUE TECHNISCHES DATENBLATT

## > Dati installazione > Installation data > Données d'installation > Installationsangaben

<b>D</b>	Materiale > Material > Matériel > Material
	d [mm] Diametro barra > Rod diameter > Diamètre de la barre > Stangedurchmesser
<b>N</b>	Tipologia di barra > Type of rod > Classe de la barre > Stange-Klasse
	Gabbietta > Plastic sleeve > Tamis > Hülse
<b>E</b>	h <sub>min</sub> [mm] Spessore minimo del supporto > Minimum thickness of base material Épaisseur minimal du material de base > Mindestbauteildicke
	d <sub>0</sub> [mm] Diametro foro > Hole diameter > Diamètre du trou > Bohrloch-Durchmesser
<b>G</b>	h <sub>1</sub> [mm] Profondità del foro > Hole depth > Profondeur du trou > Bohrlochtiefe
	h <sub>nom</sub> [mm] Profondità di inserimento > Embedment depth Profondeur d'insertion > Setztiefe
<b>L</b>	h <sub>ef</sub> [mm] Profondità effettiva ancoraggio > Effective anchorage depth Profondeur effective d'ancrage > Effektive Verankerungstiefe

<b>D</b>	S <sub>cr</sub> [mm] Interasse caratteristico > Characteristic spacing Entraxe Caractéristique > Charakteristischerachsabstand
	C <sub>cr</sub> [mm] Distanza dal bordo caratteristica > Characteristic edge distance Distance du bord caractéristique > Charakteristischerabstand
<b>N</b>	S <sub>min</sub> [mm] Interasse minimo > Minimum allowable spacing Entraxe minimale > Minimaler Achsabstand
	C <sub>min</sub> [mm] Distanza minima dal bordo > Minimum allowable edge distance Distance du bord minimale > Minimaler Randabstand
<b>E</b>	t <sub>fix</sub> [mm] Spessore fissabile > Fixture thickness Épaisseur fixable > Anbauteildicke
	d <sub>i</sub> [mm] Diametro foro spessore fissabile > Diameter of clearance hole in the fixture Diamètre du trou dans l'épaisseur fixable > Bohrloch-Durchmesser im Anbauteil
<b>G</b>	S <sub>w</sub> [mm] Chiave > Key > Clef > Schlüsselweite
	T <sub>inst</sub> [Nm] Coppia di serraggio > Installation torque Couple de serrage > Drehmoment Beim Verankern

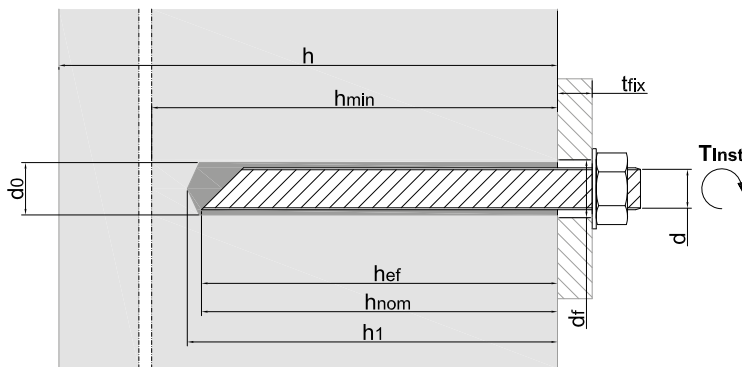

- > **NOTA:** Prima dell'installazione del prodotto consultare la presente sezione e la procedura di installazione completa riportata nelle pagine successive. Si declina ogni responsabilità per l'uso improprio del prodotto.
- > **WARNING:** Before use see this section and the complete procedure of installation reported in the next pages. We assume no liability for the not correct use of the product.
- > **NOTE:** avant l'installation du produit nous vous prions de lire cette section et la procédure d'installation complète que Vous trouvez dans les pages suivantes. Nous n'assurons pas de responsabilité pour une utilisation incorrecte du produit.
- > **ANMERKUNG:** vor der Installation des Produktes bitte diesen Abschnitt und das komplette Installationsverfahren in den folgenden Seiten lesen. Wir übernehmen keine Haftung für die inkorrekte Anwendung des Produktes.



Opzione > Option 1  
M10 ... M20

Opzione > Option 7  
M8 ... M24

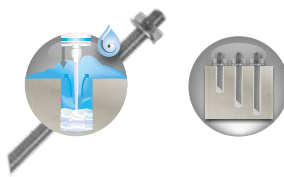

MATERIALE MATERIAL	DIAMETRO BARRA ROD DIAMETER	TIPOLOGIA DI BARRA TYPE OF ROD	SPESSORE MIN. DEL SUPPORTO MIN. THICKNESS BASE MATERIAL			DIAMETRO FORO HOLE DIAMETER	PROFONDITÀ DEL FORO HOLE DEPTH			PROFONDITÀ DI INSERIMENTO EMBEDMENT DEPTH			PROFONDITÀ EFF. ANCORAGGIO EFFECTIVE ANCHORAGE DEPTH			INTERASSE CARATTERISTICO CHARACTERISTIC SPACING			DISTANZA DAL BORDO CARATTERISTICA CHARACTERISTIC EDGE DISTANCE					
			h <sub>min</sub> [mm]	min	med		max	d <sub>0</sub> [mm]	h <sub>1</sub> [mm]	min	med	max	h <sub>nom</sub> [mm]	min	med	max	h <sub>ef</sub> [mm]	min	med	max	S <sub>cr, N</sub> [mm]	min	med	max
M8-M24 Calcestruzzo non fessurato Non cracked Concrete	M8	≥ 5.8 A4-70	100	110	190	10	65	85	165	60	80	160	60	80	160	180	230	230	90	115	115			
	M10	≥ 5.8 A4-70	100	120	230	12	75	95	205	70	90	200	70	90	200	210	248	248	105	124	124			
M10-M20 Calcestruzzo fessurato Cracked Concrete	M12	≥ 5.8 A4-70	110	140	270	14	85	115	245	80	110	240	80	110	240	240	297	297	120	149	149			
	M16	≥ 5.8 A4-70	136	161	356	18	105	130	325	100	125	320	100	125	320	300	375	396	150	188	198			
	M20	≥ 5.8 A4-70	168	218	448	24	125	175	405	120	170	400	120	170	400	360	450	450	180	225	225			
	M24	≥ 5.8 A4-70	201	266	536	28	150	215	485	145	210	480	145	210	480	435	540	540	218	270	270			





Opzione > Option 1

M10 ... M20

Opzione > Option 7

M8 ... M24

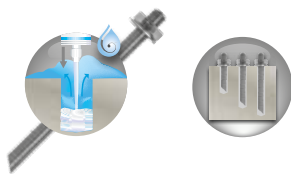

MATERIALE MATERIAL	DIAMETRO BARRA ROD DIAMETER	TIPOLOGIA DI BARRA TYPE OF ROD	INTERASSE MIN. ALLOWABLE SPACING	DISTANZA MIN. DAL BORDO MIN. ALLOWABLE EDGE DISTANCE	SPESS. FISSABILE FIXTURE THICKNESS	DIAMETRO FORO SPESS. FISSABILE DIAMETER OF CLEARANCE HOLE IN THE FIXTURE	CHIAVE KEY	COPIA DI SERRAGGIO INSTALLATION TORQUE
 M8-M24 M16-M24 Calcestruzzo non fessurato Non cracked Concrete M10-M20 Calcestruzzo fessurato Cracked Concrete  	d [mm]		S <sub>min</sub> [mm]	C <sub>min</sub> [mm]	t <sub>fix</sub> [mm] min ÷ max	d <sub>r</sub> [mm]	S <sub>w</sub> [mm]	T <sub>inst.</sub> [Nm]
	M8	≥ 5.8 A4-70	40	40	0 ÷ 1500	9	13	10
	M10	≥ 5.8 A4-70	40	40	0 ÷ 1500	12	17	20
	M12	≥ 5.8 A4-70	40	40	0 ÷ 1500	14	19	40
	M16	≥ 5.8 A4-70	50	50	0 ÷ 1500	18	24	80
	M20	≥ 5.8 A4-70	60	60	0 ÷ 1500	22	30	130
M24	≥ 5.8 A4-70	80	80	0 ÷ 1500	26	36	200	

> Per evitare una possibile rottura per splitting, lo spessore del supporto in calcestruzzo dovrà essere  $h \geq 2h_{ef}$   
 > To avoid splitting failure, the thickness of the concrete member shall be  $h \geq 2h_{ef}$   
 > Pour éviter une possible rupture par splitting, l'épaisseur du support en béton devrait être  $h \geq 2h_{ef}$   
 > Um einen splittingbedingten Bruch zu verhindern, die Dicke der Unterlage aus Beton muss  $h \geq 2h_{ef}$  sein



Ø 8 ... 32 mm



MATERIALE MATERIAL	DIAMETRO BARRA ROD DIAMETER	TIPOLOGIA DI BARRA TYPE OF ROD	DIAMETRO FORO HOLE DIAMETER	LUNGHEZZA DI ANCORAGGIO (**) ANCHORAGE LENGTH			INTERASSE MIN. MIN. ALLOWABLE SPACING	DISTANZA MIN. DAL BORDO MIN. ALLOWABLE EDGE DISTANCE		
				MIN lb	MIN lo	MAX lb		S <sub>min</sub> [mm]	C <sub>min</sub> [mm]	
 C20/25 Calcestruzzo Concrete Beton Beton  C20/25 	d [mm]		d <sub>0</sub> [mm]	l <sub>v</sub> [mm]			S <sub>min</sub> [mm]	C <sub>min</sub> [mm]		
				MIN lb	MIN lo	MAX lb		MIN lb	MIN lo	MAX lb
	Ø 8	Rebar (*)	12	115	200	400	40	37	42	54
	Ø 10	Rebar (*)	14	145	200	500	40	39	42	60
	Ø 12	Rebar (*)	16	170	200	600	48	40	42	66
	Ø 14	Rebar (*)	18	200	210	700	56	42	43	72
	Ø 16	Rebar (*)	20	230	240	800	64	44	45	78
	Ø 20	Rebar (*)	25	285	300	1000	80	47	48	90
	Ø 25	Rebar (*)	30	355	375	1000	100	61	63	100
Ø 28	Rebar (*)	35	400	420	1000	112	64	65	100	
Ø 32	Rebar (*)	40	455	480	1000	128	67	69	100	

(\*) Rebar = FeB44k; B450C; BST 500

(\*\*) Lunghezza di ancoraggio in accordo a EC2 e TR023. lb = lunghezza di ancoraggio lo = lunghezza di sovrapposizione  
 Anchorage lengths according to EC2 and TR023. lb = anchorage length lo = overlap joint length  
 Longueurs d'ancrage en accord avec EC2 et TR023. lb = longueurs d'ancrage lo = longer sous-placées  
 Verankerung Länge einigung mit EC2 und TR023. lb = Verankerung Länge lo = Überlagerung Länge



# SCHEDA TECNICA TECHNICAL DATA SHEET FICHE TECHNIQUE TECHNISCHES DATENBLATT

MATERIALE MATERIAL	DIAMETRO BARRA ROD DIAMETER	TIPOLOGIA DI BARRA TYPE OF ROD	SPESSORE MIN. DEL SUPPORTO MIN. THICKNESS BASE MATERIAL			DIAMETRO FORO HOLE DIAMETER	PROFONDITÀ DEL FORO HOLE DEPTH			PROFONDITÀ DI INSERIMENTO EMBEDMENT DEPTH			PROFONDITÀ EFF. ANCORAGGIO EFFECTIVE ANCHORAGE DEPTH			INTERASSE CARATTERISTICO CHARACTERISTIC SPACING			DISTANZA DAL BORDO CARATTERISTICA CHARACTERISTIC EDGE DISTANCE			INTERASSE MIN. ALLOWABLE SPACING			DISTANZA MIN. DAL BORDO MIN. ALLOWABLE EDGE DISTANCE		
VPLUS	d [mm]		h <sub>min</sub> [mm]			d <sub>0</sub> [mm]	h <sub>1</sub> [mm]			h <sub>nom</sub> [mm]			h <sub>eff</sub> [mm]			S <sub>cr</sub> [mm]			C <sub>e</sub> [mm]			S <sub>min</sub> [mm]			C <sub>min</sub> [mm]		
			min	med	max		min	med	max	min	med	max	min	med	max	min	med	max	min	med	max	min	med	max	min	med	max
Calcestruzzo non fessurato Non cracked Concrete Beton non fissuré Ungerissener Beton	Ø 8	Rebar (*)	100	110	190	12	65	85	165	60	80	160	60	80	160	120	160	320	60	80	160	40		40			
	Ø 10	Rebar (*)	100	120	230	14	65	95	205	60	90	200	60	90	200	120	180	400	60	90	200	45		45			
	Ø 12	Rebar (*)	102	142	275	16	75	115	245	70	110	240	70	110	240	140	220	480	70	110	240	55		55			
	Ø 14	Rebar (*)	116	161	316	18	85	130	285	80	125	280	80	125	280	160	250	560	80	125	280	63		63			
	Ø 16	Rebar (*)	120	180	360	20	85	145	325	80	140	320	80	140	320	160	280	640	80	140	320	70		70			
	Ø 20	Rebar (*)	140	220	450	25	95	175	405	90	170	400	90	170	400	180	340	800	90	170	400	85		85			
	Ø 25	Rebar (*)	160	270	560	30	105	215	505	100	210	500	100	210	500	200	420	1000	100	210	500	105		105			
	Ø 28	Rebar (*)	182	340	630	35	117	275	565	112	270	560	112	270	560	224	540	1120	112	270	560	135		135			
	Ø 32	Rebar (*)	208	380	720	40	133	305	645	128	300	640	128	300	640	256	600	1280	128	300	640	150		150			

(\*) Rebar = B450C; BST 500

> Parametri d'installazione validi per applicazioni in accordo alla teoria dell'ancoraggio > Installation parameters suitable for application according to the anchors theory  
> Paramètres d'installation en conformité avec la théorie de l'ancrage > Installationsparameter in Übereinstimmung mit der Verankerungstheorie

MATERIALE MATERIAL	DIAMETRO BARRA ROD DIAMETER	TIPOLOGIA DI BARRA TYPE OF ROD	SPESSORE MIN. DEL SUPPORTO MIN. THICKNESS BASE MATERIAL	DIAMETRO FORO HOLE DIAMETER	PROFONDITÀ DEL FORO HOLE DEPTH	PROFONDITÀ DI INSERIMENTO EMBEDMENT DEPTH	PROFONDITÀ EFF. ANCORAGGIO EFFECTIVE ANCHORAGE DEPTH	INTERASSE CARATTERISTICO CHARACTERISTIC SPACING	DISTANZA DAL BORDO CARATTERISTICA CHARACTERISTIC EDGE DISTANCE	INTERASSE MIN. ALLOWABLE SPACING	DISTANZA MIN. DAL BORDO MIN. ALLOWABLE EDGE DISTANCE	SPESS. FISSABILE MAX FIXTURE THICKNESS	DIAMETRO FORO SPESS. FISSABILE DIAMETER OF CLEARANCE HOLE IN THE FIXTURE	CHIAVE KEY	COPPIA DI SERRAGGIO INSTALLATION TORQUE
VPLUS	d [mm]		h <sub>min</sub> [mm]	d <sub>0</sub> [mm]	h <sub>1</sub> [mm]	h <sub>nom</sub> [mm]	h <sub>eff</sub> [mm]	S <sub>cr</sub> [mm]	C <sub>e</sub> [mm]	S <sub>min</sub> [mm]	C <sub>min</sub> [mm]	t <sub>fix</sub> [mm]	d <sub>r</sub> [mm]	S <sub>w</sub> [mm]	T <sub>inst</sub> [Nm]
Mattone pieno Solid Brick Brique pleine Vollmauerwerk	M8	> 4.6 A2-70 A4-70	200	10	85	80	80	160	200	100	100	10	9	13	7
	M10	> 4.6 A2-70 A4-70	250	12	90	85	85	200	200	100	100	20	12	17	15
	M12	> 4.6 A2-70 A4-70	300	14	100	95	95	240	200	100	100	30	14	19	25
	M16	> 4.6 A2-70 A4-70	350	18	130	125	125	320	200	100	100	35	18	24	30

MATERIALE MATERIAL	DIAMETRO BARRA ROD DIAMETER	TIPOLOGIA DI BARRA TYPE OF ROD	GABBIA PLASTIC SLEEVE	SPESSORE MIN. DEL SUPPORTO MIN. THICKNESS BASE MATERIAL	DIAMETRO FORO HOLE DIAMETER	PROFONDITÀ DEL FORO HOLE DEPTH	PROFONDITÀ DI INSERIMENTO EMBEDMENT DEPTH	PROFONDITÀ EFF. ANCORAGGIO EFFECTIVE ANCHORAGE DEPTH	INTERASSE CARATTERISTICO CHARACTERISTIC SPACING	DISTANZA DAL BORDO CARATTERISTICA CHARACTERISTIC EDGE DISTANCE	INTERASSE MIN. ALLOWABLE SPACING	DISTANZA MIN. DAL BORDO MIN. ALLOWABLE EDGE DISTANCE	SPESS. FISSABILE MAX FIXTURE THICKNESS	DIAMETRO FORO SPESS. FISSABILE DIAMETER OF CLEARANCE HOLE IN THE FIXTURE	CHIAVE KEY	COPPIA DI SERRAGGIO INSTALLATION TORQUE
VPLUS	d [mm]		(*)	h <sub>min</sub> [mm]	d <sub>0</sub> [mm]	h <sub>1</sub> [mm]	h <sub>nom</sub> [mm]	h <sub>eff</sub> [mm]	S <sub>cr</sub> [mm]	C <sub>e</sub> [mm]	S <sub>min</sub> [mm]	C <sub>min</sub> [mm]	t <sub>fix</sub> [mm]	d <sub>r</sub> [mm]	S <sub>w</sub> [mm]	T <sub>inst</sub> [Nm]
Mattone forato Hollow Brick Brique creux Lochziegeln	M8	> 4.6 A2-70 A4-70	GC 15x85	100	16	90	85	85	l <sub>unit,max</sub>	0,5 x l <sub>unit,max</sub>	100	100	10	9	13	5
	M10	> 4.6 A2-70 A4-70	GC 15x85	100	16	90	85	85	l <sub>unit,max</sub>	0,5 x l <sub>unit,max</sub>	100	100	20	12	17	7,5
	M12	> 4.6 A2-70 A4-70	GC 15x85	100	16	90	85	85	l <sub>unit,max</sub>	0,5 x l <sub>unit,max</sub>	100	100	30	14	19	10

(\*) Altre lunghezze disponibili, vedi catalogo > Other lengths available see catalogue

l<sub>unit,max</sub> = Massima dimensione del blocco di muratura > Max length of masonry unit > Dimension maximale du bloc de maçonnerie > Maximale Größe des Ziegelsteins

MATERIALE MATERIAL	DIAMETRO BARRA ROD DIAMETER	TIPOLOGIA DI BARRA TYPE OF ROD	SPESSORE MIN. DEL SUPPORTO MIN. THICKNESS BASE MATERIAL	DIAMETRO FORO HOLE DIAMETER	PROFONDITÀ DEL FORO HOLE DEPTH	PROFONDITÀ DI INSERIMENTO EMBEDMENT DEPTH	PROFONDITÀ EFF. ANCORAGGIO EFFECTIVE ANCHORAGE DEPTH	INTERASSE CARATTERISTICO CHARACTERISTIC SPACING	DISTANZA DAL BORDO CARATTERISTICA CHARACTERISTIC EDGE DISTANCE	INTERASSE MIN. ALLOWABLE SPACING	DISTANZA MIN. DAL BORDO MIN. ALLOWABLE EDGE DISTANCE	SPESS. FISSABILE MAX FIXTURE THICKNESS	DIAMETRO FORO SPESS. FISSABILE DIAMETER OF CLEARANCE HOLE IN THE FIXTURE	CHIAVE KEY	COPPIA DI SERRAGGIO INSTALLATION TORQUE	
VPLUS	d [mm]		h <sub>min</sub> [mm]	d <sub>0</sub> [mm]	h <sub>1</sub> [mm]	h <sub>nom</sub> [mm]	h <sub>eff</sub> [mm]	S <sub>cr</sub> [mm]	C <sub>e</sub> [mm]	S <sub>min</sub> [mm]	C <sub>min</sub> [mm]	t <sub>fix</sub> [mm]	d <sub>r</sub> [mm]	S <sub>w</sub> [mm]	T <sub>inst</sub> [Nm]	
Legno lamellare Laminated Timber Holz	M8	> 4.6 A2-70 A4-70		160	10	85	80	80	100	80	50	50	10	9	13	7
	M10	> 4.6 A2-70 A4-70		200	12	105	100	100	125	100	50	50	20	12	17	15
	M12	> 4.6 A2-70 A4-70		240	14	125	120	120	150	120	60	60	30	14	19	25
	M16	> 4.6 A2-70 A4-70		320	18	165	160	160	200	160	80	80	35	18	24	30





> **Dati carico > Load data > Données de charge > Lastdaten**

<b>D E N G E L</b>	<b>N<sub>rum</sub></b> [kN]	Carico ultimo medio a trazione > Average ultimate tension load > Charge maximum moyenne de traction Durchschnittliche maximale Zuglast
	<b>V<sub>rum</sub></b> [kN]	Carico ultimo medio a taglio > Average ultimate shear load > Charge maximum moyenne de cisaillement Durchschnittliche maximale Querlast
	<b>N<sub>rk</sub></b> [kN]	Carico caratteristico a trazione > Characteristic tension load > Charge caracteristique de traction Charakteristische Zuglast
	<b>V<sub>rk</sub></b> [kN]	Carico caratteristico a taglio > Characteristic shear load > Charge caracteristique de cisaillement Charakteristische Querlast
	<b>N<sub>rec</sub></b> [kN]	Carico ammissibile a trazione > Admissible tensile load > Charge admissible de traction > Zulässige Zuglast
	<b>V<sub>rec</sub></b> [kN]	Carico ammissibile a taglio > Admissible shear load > Charge admissible de cisaillement > Zulässige Querlast

> Carichi validi per singolo ancorante senza influenza di interasse e distanza dal bordo e  $h \geq 2h_{ef}$   
> Loads for single anchor with no influence of spacing and edge distance and with  $h \geq 2h_{ef}$   
> Charges valables pour chaque ancrage sans influence d'interaxe et distance du bord et  $h \geq 2h_{ef}$   
> Passende Ringe für den einzelnen Veranker, ohne Achsenabstandseinfluss und des Randabstands und  $h \geq 2h_{ef}$

> 1kN = 100 Kg

> Azione di taglio non diretta verso il bordo  
> Shear directed away from the edge  
> Action de cisaillement pas dirigée vers le bord  
> Queraktion nicht an den Rand gerichtet

> Coefficiente di sicurezza globale incluso  
> General safety factor included  
> Coefficient de sécurité generale inclu  
> Generelle Sicherheitskoeffizient inbegriffen

> Coefficiente lato carichi utilizzato = 1,4  
> Load increasing safety coefficient used = 1,4  
> Coefficient côté charge utilisé = 1,4  
> Verwendeter Lasterhöhungssicherheitskoeffizient = 1,4

**OPTION 1**

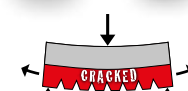

**+24°C**

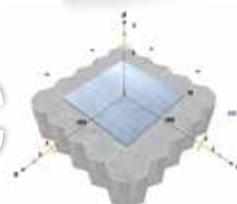

Con foro allagato, riduzione del carico consigliato del 20%  
With flooded hole, reduction of the recommended load of 20%

**MIN** Dati di carico con profondità effettiva ancoraggio MINIMA > Load data with MINIMUM effective anchorage depth  
Donnes de charge avec profondeur efficace d'ancrage MINIMALE > Lastdaten mit MINIMALER effektiven Verankerungstiefe

MATERIALE MATERIAL	BARRA ROD	DIAMETRO BARRA ROD DIAMETER	PROFONDITÀ EFF. ANCORAGGIO EFFECTIVE ANCHORAGE DEPTH	CARICO ULTIMO MEDIO A TRAZIONE	CARICO ULTIMO MEDIO A TAGLIO	CARICO CARATTERISTICO A TRAZIONE	CARICO CARATTERISTICO A TAGLIO	CARICO AMMISSIBILE A TRAZIONE	CARICO AMMISSIBILE A TAGLIO
				ULTIMATE TENSION LOAD	ULTIMATE SHEAR LOAD	CHARACTERISTIC TENSILE LOAD	CHARACTERISTIC SHEAR LOAD	ADMISSIBLE TENSILE LOAD	ADMISSIBLE SHEAR LOAD
		d [mm]	$h_{ef MIN}$ [mm]	<b>N<sub>rum</sub></b> [kN]	<b>V<sub>rum</sub></b> [kN]	<b>N<sub>rk</sub></b> [kN]	<b>V<sub>rk</sub></b> [kN]	<b>N<sub>rec</sub></b> [kN]	<b>V<sub>rec</sub></b> [kN]
<b>C20/25</b> <b>Calcestruzzo fessurato</b> <b>Cracked Concrete</b> <b>Beton fissuré</b> <b>Gerissener Beton</b> 	$\geq 5.8$	M 10	70	27,8	18,1	19,1	15,1	9,1	8,6
	$\geq 5.8$	M 12	80	33,9	26,3	25,8	21,9	12,2	12,5
	$\geq 5.8$	M 16	100	47,5	48,9	36,0	40,8	17,1	23,3
	$\geq 5.8$	M 20	120	62,4	76,2	47,3	63,5	22,5	34,3



**MED** Dati di carico con profondità effettiva ancoraggio MEDIA > Load data with MEDIUM effective anchorage depth  
Donnes de charge avec profondeur efficace d'ancrage MOYENNE > Lastdaten mit MITTLERER effektiven Verankerungstiefe

MATERIALE MATERIAL	BARRA ROD	DIAMETRO BARRA ROD DIAMETER	PROFONDITÀ EFF. ANCORAGGIO EFFECTIVE ANCHORAGE DEPTH	CARICO ULTIMO MEDIO A TRAZIONE	CARICO ULTIMO MEDIO A TAGLIO	CARICO CARATTERISTICO A TRAZIONE	CARICO CARATTERISTICO A TAGLIO	CARICO AMMISSIBILE A TRAZIONE	CARICO AMMISSIBILE A TAGLIO
				ULTIMATE TENSION LOAD	ULTIMATE SHEAR LOAD	CHARACTERISTIC TENSILE LOAD	CHARACTERISTIC SHEAR LOAD	ADMISSIBLE TENSILE LOAD	ADMISSIBLE SHEAR LOAD
		d [mm]	$h_{ef MED}$ [mm]	<b>N<sub>rum</sub></b> [kN]	<b>V<sub>rum</sub></b> [kN]	<b>N<sub>rk</sub></b> [kN]	<b>V<sub>rk</sub></b> [kN]	<b>N<sub>rec</sub></b> [kN]	<b>V<sub>rec</sub></b> [kN]
<b>C20/25</b> <b>Calcestruzzo fessurato</b> <b>Cracked Concrete</b> <b>Beton fissuré</b> <b>Gerissener Beton</b> 	$\geq 5.8$	M 10	90	30,2	18,1	24,6	15,1	11,7	8,6
	$\geq 5.8$	M 12	110	43,8	26,3	37,5	21,9	17,8	12,5
	$\geq 5.8$	M 16	125	66,3	48,9	50,3	40,8	23,9	23,3
	$\geq 5.8$	M 20	170	104,4	76,2	71,0	63,5	33,8	36,2



**MAX** Dati di carico con profondità effettiva ancoraggio MASSIMO > Load data with MAXIMUM effective anchorage depth  
Donnes de charge avec profondeur efficace d'ancrage MAXIMUM > Lastdaten mit MAXIMALER effektiven Verankerungstiefe

MATERIALE MATERIAL	BARRA ROD	DIAMETRO BARRA ROD DIAMETER	PROFONDITÀ EFF. ANCORAGGIO EFFECTIVE ANCHORAGE DEPTH	CARICO ULTIMO MEDIO A TRAZIONE	CARICO ULTIMO MEDIO A TAGLIO	CARICO CARATTERISTICO A TRAZIONE	CARICO CARATTERISTICO A TAGLIO	CARICO AMMISSIBILE A TRAZIONE	CARICO AMMISSIBILE A TAGLIO
				ULTIMATE TENSION LOAD	ULTIMATE SHEAR LOAD	CHARACTERISTIC TENSILE LOAD	CHARACTERISTIC SHEAR LOAD	ADMISSIBLE TENSILE LOAD	ADMISSIBLE SHEAR LOAD
		d [mm]	$h_{ef MAX}$ [mm]	<b>N<sub>rum</sub></b> [kN]	<b>V<sub>rum</sub></b> [kN]	<b>N<sub>rk</sub></b> [kN]	<b>V<sub>rk</sub></b> [kN]	<b>N<sub>rec</sub></b> [kN]	<b>V<sub>rec</sub></b> [kN]
<b>C20/25</b> <b>Calcestruzzo fessurato</b> <b>Cracked Concrete</b> <b>Beton fissuré</b> <b>Gerissener Beton</b> 	8.8	M 10	200	46,4	27,8	46,4	23,2	22,1	13,2
	8.8	M 12	240	67,4	40,4	67,4	33,7	32,1	19,2
	8.8	M 16	320	125,0	75,0	125,0	62,5	59,5	35,7
	8.8	M 20	400	203,0	121,8	167,0	101,5	79,5	58,0





# SCHEDA TECNICA TECHNICAL DATA SHEET FICHE TECHNIQUE TECHNISCHES DATENBLATT

## > Dati carico > Load data > Données de charge > Lastdaten

<b>D E N E L</b>	<b>N<sub>um</sub></b> [kN]	Carico ultimo medio a trazione > Average ultimate tension load > Charge maximum moyenne de traction Durchschnittliche maximale Zuglast
	<b>V<sub>um</sub></b> [kN]	Carico ultimo medio a taglio > Average ultimate shear load > Charge maximum moyenne de cisaillement Durchschnittliche maximale Querlast
	<b>N<sub>rk</sub></b> [kN]	Carico caratteristico a trazione > Characteristic tension load > Charge caracteristique de traction Caratteristische Zuglast
	<b>V<sub>rk</sub></b> [kN]	Carico caratteristico a taglio > Characteristic shear load > Charge caracteristique de cisaillement Caratteristische Querlast
	<b>N<sub>rec</sub></b> [kN]	Carico ammissibile a trazione > Admissible tensile load > Charge admissible de traction > Zulässige Zuglast
	<b>V<sub>rec</sub></b> [kN]	Carico ammissibile a taglio > Admissible shear load > Charge admissible de cisaillement > Zulässige Querlast

> Carichi validi per singolo ancorante senza influenza di interasse e distanza dal bordo e  $h \geq 2h_f$   
 > Loads for single anchor with no influence of spacing and edge distance and with  $h \geq 2h_f$   
 > Charges valables pour chaque ancrage sans influence d'interaxe et distance du bord et  $h \geq 2h_f$   
 > Passende Ringe für den einzelnen Veranker, ohne Achsenabstandseinfluss und des Randabstands und  $h \geq 2h_f$

> Azione di taglio non diretta verso il bordo > Coefficiente di sicurezza globale incluso > Coefficiente lato carichi utilizzato = 1,4  
 > Shear directed away from the edge > General safety factor included > Load increasing safety coefficient used = 1,4  
 > Action de cisaillement pas dirigée vers le bord > Coefficient de sécurité generale inclu > Coefficient côté charge utilisé = 1,4  
 > Queraktion nicht an den Rand gerichtet > Generelle Sicherheitskoeffizient inbegriffen > Verwendeter Lasterhöhungssicherheitskoeffizient = 1,4



Con foro allagato, riduzione del carico consigliato del 20%  
 With flooded hole, reduction of the recommended load of 20%

## MIN Dati di carico con profondità effettiva ancoraggio MINIMA > Load data with MINIMUM effective anchorage depth Données de charge avec profondeur efficace d'ancrage MINIMALE > Lastdaten mit MINIMALER effektiven Verankerungstiefe

MATERIALE MATERIAL	BARRA ROD	DIAMETRO BARRA ROD DIAMETER	PROFONDITÀ EFF. ANCORAGGIO EFFECTIVE ANCHORAGE DEPTH	CARICO ULTIMO MEDIO A TRAZIONE ULTIMATE TENSION LOAD	CARICO ULTIMO MEDIO A TAGLIO ULTIMATE SHEAR LOAD	CARICO CARATTERISTICO A TRAZIONE CHARACTERISTIC TENSILE LOAD	CARICO CARATTERISTICO A TAGLIO CHARACTERISTIC SHEAR LOAD	CARICO AMMISSIBILE A TRAZIONE ADMISSIBLE TENSILE LOAD	CARICO AMMISSIBILE A TAGLIO ADMISSIBLE SHEAR LOAD
				N <sub>um</sub> [kN]	V <sub>um</sub> [kN]	N <sub>rk</sub> [kN]	V <sub>rk</sub> [kN]	N <sub>rec</sub> [kN]	V <sub>rec</sub> [kN]
C20/25 Calcestruzzo non fessurato Non cracked Concrete Béton non fissuré Ungerissener Beton	≥ 5.8	M 8	60	19,0	11,4	19,0	9,5	9,0	5,4
	≥ 5.8	M 10	70	30,2	18,1	25,2	15,1	12,0	8,6
	≥ 5.8	M 12	80	43,8	26,3	35,7	21,9	17,0	12,5
	≥ 5.8	M 16	100	67,5	48,9	50,5	40,8	24,0	23,3
	≥ 5.8	M 20	120	88,7	76,2	66,3	63,5	31,6	36,3
	≥ 5.8	M 24	145	117,8	110,4	88,1	92,0	41,9	52,5

## MED Dati di carico con profondità effettiva ancoraggio MEDIA > Load data with MEDIUM effective anchorage depth Données de charge avec profondeur efficace d'ancrage MOYENNE > Lastdaten mit MITTLERER effektiven Verankerungstiefe

MATERIALE MATERIAL	BARRA ROD	DIAMETRO BARRA ROD DIAMETER	PROFONDITÀ EFF. ANCORAGGIO EFFECTIVE ANCHORAGE DEPTH	CARICO ULTIMO MEDIO A TRAZIONE ULTIMATE TENSION LOAD	CARICO ULTIMO MEDIO A TAGLIO ULTIMATE SHEAR LOAD	CARICO CARATTERISTICO A TRAZIONE CHARACTERISTIC TENSILE LOAD	CARICO CARATTERISTICO A TAGLIO CHARACTERISTIC SHEAR LOAD	CARICO AMMISSIBILE A TRAZIONE ADMISSIBLE TENSILE LOAD	CARICO AMMISSIBILE A TAGLIO ADMISSIBLE SHEAR LOAD
				N <sub>um</sub> [kN]	V <sub>um</sub> [kN]	N <sub>rk</sub> [kN]	V <sub>rk</sub> [kN]	N <sub>rec</sub> [kN]	V <sub>rec</sub> [kN]
C20/25 Calcestruzzo non fessurato Non cracked Concrete Béton non fissuré Ungerissener Beton	≥ 5.8	M 8	80	19,0	11,4	19,0	9,5	9,0	5,4
	≥ 5.8	M 10	90	30,2	18,1	30,2	15,1	14,3	8,6
	≥ 5.8	M 12	110	43,8	26,3	43,8	21,9	20,8	12,5
	≥ 5.8	M 16	125	81,6	48,9	70,5	40,8	33,6	23,3
	≥ 5.8	M 20	170	127,0	76,2	104,7	63,5	49,8	36,3
	≥ 5.8	M 24	210	184,0	110,4	153,2	92,0	72,9	52,5

## MAX Dati di carico con profondità effettiva ancoraggio MASSIMO > Load data with MAXIMUM effective anchorage depth Données de charge avec profondeur efficace d'ancrage MAXIMUM > Lastdaten mit MAXIMALER effektiven Verankerungstiefe

MATERIALE MATERIAL	BARRA ROD	DIAMETRO BARRA ROD DIAMETER	PROFONDITÀ EFF. ANCORAGGIO EFFECTIVE ANCHORAGE DEPTH	CARICO ULTIMO MEDIO A TRAZIONE ULTIMATE TENSION LOAD	CARICO ULTIMO MEDIO A TAGLIO ULTIMATE SHEAR LOAD	CARICO CARATTERISTICO A TRAZIONE CHARACTERISTIC TENSILE LOAD	CARICO CARATTERISTICO A TAGLIO CHARACTERISTIC SHEAR LOAD	CARICO AMMISSIBILE A TRAZIONE ADMISSIBLE TENSILE LOAD	CARICO AMMISSIBILE A TAGLIO ADMISSIBLE SHEAR LOAD
				N <sub>um</sub> [kN]	V <sub>um</sub> [kN]	N <sub>rk</sub> [kN]	V <sub>rk</sub> [kN]	N <sub>rec</sub> [kN]	V <sub>rec</sub> [kN]
C20/25 Calcestruzzo non fessurato Non cracked Concrete Béton non fissuré Ungerissener Beton	8.8	M 8	160	29,2	17,5	29,2	14,6	13,9	8,3
	8.8	M 10	200	46,4	27,8	46,4	23,2	22,1	13,2
	8.8	M 12	240	67,4	40,4	67,4	33,7	32,1	19,2
	8.8	M 16	320	125,0	75,0	125,0	62,5	59,5	35,7
	8.8	M 20	400	203,0	121,8	203,0	101,5	96,6	58,0
	8.8	M 24	480	293,0	175,8	293,0	146,5	139,5	83,7





> **Dati carico > Load data > Données de charge > Lastdaten**

<b>D E N G E L</b>	<b>N<sub>rum</sub></b> [kN]	Carico ultimo medio a trazione > Average ultimate tension load > Charge maximum moyenne de traction Durchschnittliche maximale Zuglast
	<b>V<sub>rum</sub></b> [kN]	Carico ultimo medio a taglio > Average ultimate shear load > Charge maximum moyenne de cisaillement Durchschnittliche maximale Querlast
	<b>N<sub>rk</sub></b> [kN]	Carico caratteristico a trazione > Characteristic tension load > Charge caracteristique de traction Charakteristische Zuglast
	<b>V<sub>rk</sub></b> [kN]	Carico caratteristico a taglio > Characteristic shear load > Charge caracteristique de cisaillement Charakteristische Querlast
	<b>N<sub>rec</sub></b> [kN]	Carico ammissibile a trazione > Admissible tensile load > Charge admissible de traction > Zulässige Zuglast
	<b>V<sub>rec</sub></b> [kN]	Carico ammissibile a taglio > Admissible shear load > Charge admissible de cisaillement > Zulässige Querlast

> Carichi validi per singolo ancorante senza influenza di interasse e distanza dal bordo e  $h \geq 2h_{ef}$  > 1kN = 100 Kg  
> Loads for single anchor with no influence of spacing and edge distance and with  $h \geq 2h_{ef}$   
> Charges valables pour chaque ancrage sans influence d'interaxe et distance du bord et  $h \geq 2h_{ef}$   
> Passende Ringe für den einzelnen Veranker, ohne Achsenabstandseinfluss und des Randabstands und  $h \geq 2h_{ef}$

> Azione di taglio non diretta verso il bordo > Coefficiente di sicurezza globale incluso > Coefficiente lato carichi utilizzato = 1,4  
> Shear directed away from the edge > General safety factor included > Load increasing safety coefficient used = 1,4  
> Action de cisaillement pas dirigée vers le bord > Coefficient de sécurité generale inclu > Coefficient côté charge utilisé = 1,4  
> Queraktion nicht an den Rand gerichtet > Generelle Sicherheitskoeffizient inbegriffen > Verwendeter Lasterhöhungssicherheitskoeffizient = 1,4

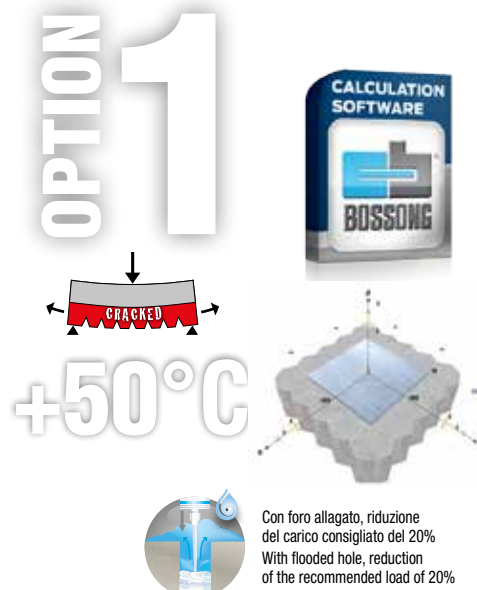

Con foro allagato, riduzione del carico consigliato del 20%  
With flooded hole, reduction of the recommended load of 20%

**MIN** Dati di carico con profondità effettiva ancoraggio MINIMA > Load data with MINIMUM effective anchorage depth  
Donnes de charge avec profondeur efficace d'ancrage MINIMALE > Lastdaten mit MINIMALER effektiven Verankerungstiefe

MATERIALE MATERIAL	BARRA ROD	DIAMETRO BARRA ROD DIAMETER	PROFONDITÀ EFF. ANCORAGGIO EFFECTIVE ANCHORAGE DEPTH	CARICO ULTIMO MEDIO A TRAZIONE	CARICO ULTIMO MEDIO A TAGLIO	CARICO CARATTERISTICO A TRAZIONE	CARICO CARATTERISTICO A TAGLIO	CARICO AMMISSIBILE A TRAZIONE	CARICO AMMISSIBILE A TAGLIO
				ULTIMATE TENSION LOAD	ULTIMATE SHEAR LOAD	CHARACTERISTIC TENSILE LOAD	CHARACTERISTIC SHEAR LOAD	ADMISSIBLE TENSILE LOAD	ADMISSIBLE SHEAR LOAD
		d [mm]	$h_{ef MIN}$ [mm]	<b>N<sub>rum</sub></b> [kN]	<b>V<sub>rum</sub></b> [kN]	<b>N<sub>rk</sub></b> [kN]	<b>V<sub>rk</sub></b> [kN]	<b>N<sub>rec</sub></b> [kN]	<b>V<sub>rec</sub></b> [kN]
<b>C20/25</b> <b>Calcestruzzo fessurato</b> <b>Cracked Concrete</b> <b>Beton fissuré</b> <b>Gerissener Beton</b> 	$\geq 5.8$	M 10	70	27,8	18,1	13,8	15,1	6,5	8,6
	$\geq 5.8$	M 12	80	33,9	26,3	19,6	21,9	9,3	12,5
	$\geq 5.8$	M 16	100	47,5	48,9	29,5	40,8	14,0	23,3
	$\geq 5.8$	M 20	120	62,4	76,2	36,0	63,5	17,1	34,3



**MED** Dati di carico con profondità effettiva ancoraggio MEDIA > Load data with MEDIUM effective anchorage depth  
Donnes de charge avec profondeur efficace d'ancrage MOYENNE > Lastdaten mit MITTLERER effektiven Verankerungstiefe

MATERIALE MATERIAL	BARRA ROD	DIAMETRO BARRA ROD DIAMETER	PROFONDITÀ EFF. ANCORAGGIO EFFECTIVE ANCHORAGE DEPTH	CARICO ULTIMO MEDIO A TRAZIONE	CARICO ULTIMO MEDIO A TAGLIO	CARICO CARATTERISTICO A TRAZIONE	CARICO CARATTERISTICO A TAGLIO	CARICO AMMISSIBILE A TRAZIONE	CARICO AMMISSIBILE A TAGLIO
				ULTIMATE TENSION LOAD	ULTIMATE SHEAR LOAD	CHARACTERISTIC TENSILE LOAD	CHARACTERISTIC SHEAR LOAD	ADMISSIBLE TENSILE LOAD	ADMISSIBLE SHEAR LOAD
		d [mm]	$h_{ef MED}$ [mm]	<b>N<sub>rum</sub></b> [kN]	<b>V<sub>rum</sub></b> [kN]	<b>N<sub>rk</sub></b> [kN]	<b>V<sub>rk</sub></b> [kN]	<b>N<sub>rec</sub></b> [kN]	<b>V<sub>rec</sub></b> [kN]
<b>C20/25</b> <b>Calcestruzzo fessurato</b> <b>Cracked Concrete</b> <b>Beton fissuré</b> <b>Gerissener Beton</b> 	$\geq 5.8$	M 10	90	30,2	18,1	17,7	15,1	8,4	8,6
	$\geq 5.8$	M 12	110	43,8	26,3	27,0	21,9	12,8	12,5
	$\geq 5.8$	M 16	125	66,3	48,9	36,9	40,8	17,6	23,3
	$\geq 5.8$	M 20	170	104,4	76,2	51,1	63,5	24,3	36,2



**MAX** Dati di carico con profondità effettiva ancoraggio MASSIMO > Load data with MAXIMUM effective anchorage depth  
Donnes de charge avec profondeur efficace d'ancrage MAXIMUM > Lastdaten mit MAXIMALER effektiven Verankerungstiefe

MATERIALE MATERIAL	BARRA ROD	DIAMETRO BARRA ROD DIAMETER	PROFONDITÀ EFF. ANCORAGGIO EFFECTIVE ANCHORAGE DEPTH	CARICO ULTIMO MEDIO A TRAZIONE	CARICO ULTIMO MEDIO A TAGLIO	CARICO CARATTERISTICO A TRAZIONE	CARICO CARATTERISTICO A TAGLIO	CARICO AMMISSIBILE A TRAZIONE	CARICO AMMISSIBILE A TAGLIO
				ULTIMATE TENSION LOAD	ULTIMATE SHEAR LOAD	CHARACTERISTIC TENSILE LOAD	CHARACTERISTIC SHEAR LOAD	ADMISSIBLE TENSILE LOAD	ADMISSIBLE SHEAR LOAD
		d [mm]	$h_{ef MAX}$ [mm]	<b>N<sub>rum</sub></b> [kN]	<b>V<sub>rum</sub></b> [kN]	<b>N<sub>rk</sub></b> [kN]	<b>V<sub>rk</sub></b> [kN]	<b>N<sub>rec</sub></b> [kN]	<b>V<sub>rec</sub></b> [kN]
<b>C20/25</b> <b>Calcestruzzo fessurato</b> <b>Cracked Concrete</b> <b>Beton fissuré</b> <b>Gerissener Beton</b> 	8.8	M 10	200	46,4	27,8	39,4	23,2	18,7	13,2
	8.8	M 12	240	67,4	40,4	58,9	33,7	28,0	19,2
	8.8	M 16	320	125,0	75,0	94,6	62,5	45,0	35,7
	8.8	M 20	400	203,0	121,8	120,2	101,5	57,2	58,0





# SCHEDA TECNICA TECHNICAL DATA SHEET FICHE TECHNIQUE TECHNISCHES DATENBLATT

## > Dati carico > Load data > Données de charge > Lastdaten

<b>D E N E L</b>	$N_{num}$ [kN]	Carico ultimo medio a trazione > Average ultimate tension load > Charge maximum moyenne de traction Durchschnittliche maximale Zuglast
	$V_{num}$ [kN]	Carico ultimo medio a taglio > Average ultimate shear load > Charge maximum moyenne de cisaillement Durchschnittliche maximale Querlast
	$N_{rk}$ [kN]	Carico caratteristico a trazione > Characteristic tension load > Charge caractéristique de traction Caratteristica Zuglast
	$V_{rk}$ [kN]	Carico caratteristico a taglio > Characteristic shear load > Charge caractéristique de cisaillement Caratteristica Querlast
	$N_{rec}$ [kN]	Carico ammissibile a trazione > Admissible tensile load > Charge admissible de traction > Zulässige Zuglast
	$V_{rec}$ [kN]	Carico ammissibile a taglio > Admissible shear load > Charge admissible de cisaillement > Zulässige Querlast

> Carichi validi per singolo ancorante senza influenza di interasse e distanza dal bordo e  $h \geq 2h_{ef}$  > 1kN = 100 Kg  
 > Loads for single anchor with no influence of spacing and edge distance and with  $h \geq 2h_{ef}$   
 > Charges valables pour chaque ancrage sans influence d'interaxe et distance du bord et  $h \geq 2h_{ef}$   
 > Passende Ringe für den einzelnen Veranker, ohne Achsenabstandseinfluss und des Randabstands und  $h \geq 2h_{ef}$

> Azione di taglio non diretta verso il bordo > Coefficiente di sicurezza globale incluso > Coefficiente lato carichi utilizzato = 1,4  
 > Shear directed away from the edge > General safety factor included > Load increasing safety coefficient used = 1,4  
 > Action de cisaillement pas dirigée vers le bord > Coefficient de sécurité générale inclu > Coefficient côté charge utilisé = 1,4  
 > Queraktion nicht an den Rand gerichtet > Generelle Sicherheitskoeffizient inbegriffen > Verwendeter Lasterhöhungssicherheitskoeffizient = 1,4

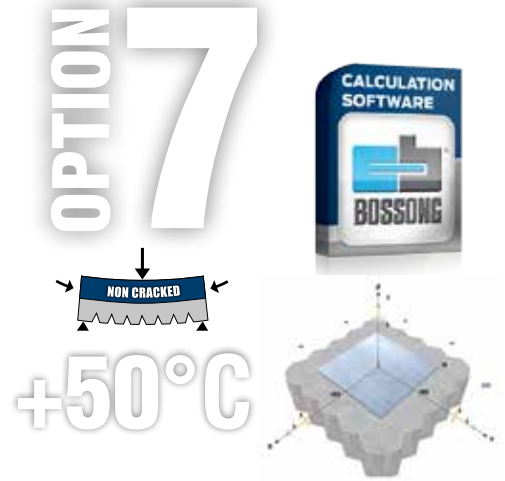

Con foro allagato, riduzione del carico consigliato del 20%  
With flooded hole, reduction of the recommended load of 20%

## MIN Dati di carico con profondità effettiva ancoraggio MINIMA > Load data with MINIMUM effective anchorage depth Donnes de charge avec profondeur efficace d'ancrage MINIMALE > Lastdaten mit MINIMALER effektiven Verankerungstiefe

MATERIALE MATERIAL	BARRA ROD	DIAMETRO BARRA ROD DIAMETER	PROFONDITÀ EFF. ANCORAGGIO EFFECTIVE ANCHORAGE DEPTH	CARICO ULTIMO MEDIO A TRAZIONE ULTIMATE TENSION LOAD	CARICO ULTIMO MEDIO A TAGLIO ULTIMATE SHEAR LOAD	CARICO CARATTERISTICO A TRAZIONE CHARACTERISTIC TENSILE LOAD	CARICO CARATTERISTICO A TAGLIO CHARACTERISTIC SHEAR LOAD	CARICO AMMISSIBILE A TRAZIONE ADMISSIBLE TENSILE LOAD	CARICO AMMISSIBILE A TAGLIO ADMISSIBLE SHEAR LOAD	
				$N_{num}$ [kN]	$V_{num}$ [kN]	$N_{rk}$ [kN]	$V_{rk}$ [kN]	$N_{rec}$ [kN]	$V_{rec}$ [kN]	
C20/25 Calcestruzzo non fessurato Non cracked Concrete Beton non fissuré Ungerissener Beton		$\geq 5.8$	M 8	60	19,0	11,4	17,2	9,5	8,2	5,4
		$\geq 5.8$	M 10	70	30,2	18,1	18,1	15,1	8,6	8,6
		$\geq 5.8$	M 12	80	43,8	26,3	25,7	21,9	12,2	12,5
		$\geq 5.8$	M 16	100	67,5	48,9	42,6	40,8	20,3	23,3
		$\geq 5.8$	M 20	120	88,7	76,2	53,2	63,5	25,3	36,3
		$\geq 5.8$	M 24	145	117,8	110,4	76,1	92,0	36,2	52,5

## MED Dati di carico con profondità effettiva ancoraggio MEDIA > Load data with MEDIUM effective anchorage depth Donnes de charge avec profondeur efficace d'ancrage MOYENNE > Lastdaten mit MITTLERER effektiven Verankerungstiefe

MATERIALE MATERIAL	BARRA ROD	DIAMETRO BARRA ROD DIAMETER	PROFONDITÀ EFF. ANCORAGGIO EFFECTIVE ANCHORAGE DEPTH	CARICO ULTIMO MEDIO A TRAZIONE ULTIMATE TENSION LOAD	CARICO ULTIMO MEDIO A TAGLIO ULTIMATE SHEAR LOAD	CARICO CARATTERISTICO A TRAZIONE CHARACTERISTIC TENSILE LOAD	CARICO CARATTERISTICO A TAGLIO CHARACTERISTIC SHEAR LOAD	CARICO AMMISSIBILE A TRAZIONE ADMISSIBLE TENSILE LOAD	CARICO AMMISSIBILE A TAGLIO ADMISSIBLE SHEAR LOAD	
				$N_{num}$ [kN]	$V_{num}$ [kN]	$N_{rk}$ [kN]	$V_{rk}$ [kN]	$N_{rec}$ [kN]	$V_{rec}$ [kN]	
C20/25 Calcestruzzo non fessurato Non cracked Concrete Beton non fissuré Ungerissener Beton		$\geq 5.8$	M 8	80	19,0	11,4	19,0	9,5	9,0	5,4
		$\geq 5.8$	M 10	90	30,2	18,1	23,3	15,1	11,1	8,6
		$\geq 5.8$	M 12	110	43,8	26,3	35,4	21,9	16,8	12,5
		$\geq 5.8$	M 16	125	81,6	48,9	53,3	40,8	25,3	23,3
		$\geq 5.8$	M 20	170	127,0	76,2	75,3	63,5	35,9	36,3
		$\geq 5.8$	M 24	210	184,0	110,4	110,3	92,0	52,5	52,5

## MAX Dati di carico con profondità effettiva ancoraggio MASSIMO > Load data with MAXIMUM effective anchorage depth Donnes de charge avec profondeur efficace d'ancrage MAXIMUM > Lastdaten mit MAXIMALER effektiven Verankerungstiefe

MATERIALE MATERIAL	BARRA ROD	DIAMETRO BARRA ROD DIAMETER	PROFONDITÀ EFF. ANCORAGGIO EFFECTIVE ANCHORAGE DEPTH	CARICO ULTIMO MEDIO A TRAZIONE ULTIMATE TENSION LOAD	CARICO ULTIMO MEDIO A TAGLIO ULTIMATE SHEAR LOAD	CARICO CARATTERISTICO A TRAZIONE CHARACTERISTIC TENSILE LOAD	CARICO CARATTERISTICO A TAGLIO CHARACTERISTIC SHEAR LOAD	CARICO AMMISSIBILE A TRAZIONE ADMISSIBLE TENSILE LOAD	CARICO AMMISSIBILE A TAGLIO ADMISSIBLE SHEAR LOAD	
				$N_{num}$ [kN]	$V_{num}$ [kN]	$N_{rk}$ [kN]	$V_{rk}$ [kN]	$N_{rec}$ [kN]	$V_{rec}$ [kN]	
C20/25 Calcestruzzo non fessurato Non cracked Concrete Beton non fissuré Ungerissener Beton		8.8	M 8	160	29,2	17,5	29,2	14,6	13,9	8,3
		8.8	M 10	200	46,4	27,8	46,4	23,2	22,1	13,2
		8.8	M 12	240	67,4	40,4	67,4	33,7	32,1	19,2
		8.8	M 16	320	125,0	75,0	125,0	62,5	59,5	35,7
		8.8	M 20	400	203,0	121,8	177,3	101,5	84,4	58,0
		8.8	M 24	480	293,0	175,8	252,1	146,5	120,0	83,7



Dati di tensione di aderenza fbd validi per tutte le lunghezze di ancoraggio > Design value of bond strength fbd suitable for all anchorage lengths  
Données de tension et d'adhérence fbd valables pour toutes les longueurs d'ancrage > Bemessungswert der Verbundspannung fbd Gültig für alle Ankerungslänge



MATERIALE MATERIAL	TIPOLOGIA DI BARRA TYPE OF ROD	DIAMETRO BARRA ROD DIAMETER	TENSIONE DI ADERENZA fbd [N/mm <sup>2</sup> ] > BOND RESISTANCE fbd [N/mm <sup>2</sup> ]								
			d [mm]	C 12/15	C 16/20	C 20/25	C 25/30	C 30/37	C 35/45	C 40/50	C 45/55
<b>Calcestruzzo</b> <b>Concrete</b> <b>Beton</b>   ETAG 001 TR023 ETA-09/0246  (*) Rebar = B450C; BST 500	Rebar (*)	Ø 8	1,6	2,0	2,3	2,7	3,0	3,4	3,7	4,0	4,3
	Rebar (*)	Ø 10	1,6	2,0	2,3	2,7	3,0	3,4	3,7	4,0	4,3
	Rebar (*)	Ø 12	1,6	2,0	2,3	2,7	3,0	3,4	3,7	4,0	4,3
	Rebar (*)	Ø 14	1,6	2,0	2,3	2,7	3,0	3,4	3,7	4,0	4,3
	Rebar (*)	Ø 16	1,6	2,0	2,3	2,7	3,0	3,4	3,7	4,0	4,0
	Rebar (*)	Ø 20	1,6	2,0	2,3	2,7	3,0	3,4	3,7	4,0	4,0
	Rebar (*)	Ø 25	1,6	2,0	2,3	2,7	3,0	3,4	3,7	3,7	3,7
	Rebar (*)	Ø 28	1,6	2,0	2,3	2,7	3,0	3,4	3,4	3,4	3,4
	Rebar (*)	Ø 32	1,6	2,0	2,3	2,7	2,7	2,7	2,7	2,7	2,7

MATERIALE MATERIAL	TIPOLOGIA DI BARRA TYPE OF ROD	DIAMETRO BARRA ROD DIAMETER	CARICO ULTIMO MEDIO A TRAZIONE ULTIMATE TENSION LOAD	CARICO ULTIMO MEDIO A TAGLIO ULTIMATE SHEAR LOAD	CARICO AMMISSIBILE A TRAZIONE ADMISSIBLE TENSILE LOAD	CARICO AMMISSIBILE A TAGLIO ADMISSIBLE SHEAR LOAD
			N <sub>lim</sub> [kN]	V <sub>lim</sub> [kN]	N <sub>rec</sub> [kN]	V <sub>rec</sub> [kN]
<b>Mattone pieno</b> <b>Solid Brick</b> <b>Brique pleine</b> <b>Vollmauerwerk</b>  ≥ 4.6 / A2-70 / A4-70 	≥ 4.6 A2-70 A4 -70	M8	 > Dati di carico raccomandati per applicazioni su materiali base di medie caratteristiche meccaniche. Vista la varietà dei substrati in muratura e/o legno per applicazioni su supporti differenti da quelli considerati, i valori di carico dovranno essere ricavati tramite opportune prove in situ. > Recommended loads for applications on base materials with medium strength characteristics. For different masonry and/or wood base materials, load values must be obtained with in situ tests.		2,0	3,0
	≥ 4.6 A2-70 A4 -70	M10		2,6	3,4	
	≥ 4.6 A2-70 A4 -70	M12		2,8	3,9	
	≥ 4.6 A2-70 A4 -70	M16		4,0	4,2	
<b>Materiale forato</b> <b>Hollow Material</b> <b>Material creuse</b> <b>Lochziegeln</b>  ≥ 4.6 / A2-70 / A4-70 	≥ 4.6 A2-70 A4 -70	M8		0,9	2,0	
	≥ 4.6 A2-70 A4 -70	M10		0,9	2,0	
	≥ 4.6 A2-70 A4 -70	M12		0,9	2,5	
<b>Legno lamellare</b> <b>Laminated Timber</b> <b>Timber</b> <b>Holz</b>  ≥ 4.6 / A2-70 / A4-70 	≥ 4.6 A2-70 A4 -70	M8		3,2	> Per valori a taglio riferirsi alle istruzioni CNR-DT 206/2007 (7.10.2.3) > For shear loads refer to CNR-DT 206/2007 (7.10.2.3)	
	≥ 4.6 A2-70 A4 -70	M10		4,2		
	≥ 4.6 A2-70 A4 -70	M12		6,1		
	≥ 4.6 A2-70 A4 -70	M16	10,7			





# SCHEDA TECNICA TECHNICAL DATA SHEET FICHE TECHNIQUE TECHNISCHES DATENBLATT

## > Dati carico > Load data > Données de charge > Lastdaten

<b>D E N G E L</b>	$N_{rum}$ [kN]	Carico ultimo medio a trazione > Average ultimate tension load > Charge maximum moyenne de traction Durchschnittliche maximale Zuglast
	$V_{rum}$ [kN]	Carico ultimo medio a taglio > Average ultimate shear load > Charge maximum moyenne de cisaillement Durchschnittliche maximale Querlast
	$N_{rk}$ [kN]	Carico caratteristico a trazione > Characteristic tension load > Charge caractéristique de traction Caratteristica Zuglast
	$V_{rk}$ [kN]	Carico caratteristico a taglio > Characteristic shear load > Charge caractéristique de cisaillement Caratteristica Querlast
	$N_{rec}$ [kN]	Carico ammissibile a trazione > Admissible tensile load > Charge admissible de traction > Zulässige Zuglast
	$V_{rec}$ [kN]	Carico ammissibile a taglio > Admissible shear load > Charge admissible de cisaillement > Zulässige Querlast

- > Applicazioni in accordo alla teoria dell'ancoraggio
- > Application according to the anchors theory
- > Application en conformité avec la théorie de l'ancrage
- > Anwendung in Übereinstimmung mit der Verankerungstheorie

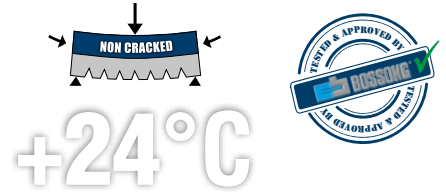

- > Carichi validi per singolo ancorante senza influenza di interasse e distanza dal bordo e  $h \geq 2h_f$  > 1kN = 100 Kg
- > Loads for single anchor with no influence of spacing and edge distance and with  $h \geq 2h_f$
- > Charges valables pour chaque ancrage sans influence d'interaxe et distance du bord et  $h \geq 2h_f$
- > Passende Ringe für den einzelnen Veranker, ohne Achsenabstandseinfluss und des Randabstands und  $h \geq 2h_f$

- > Azione di taglio non diretta verso il bordo > Coefficiente di sicurezza globale incluso > Coefficiente lato carichi utilizzato = 1,4
- > Shear directed away from the edge > General safety factor included > Load increasing safety coefficient used = 1,4
- > Action de cisaillement pas dirigée vers le bord > Coefficient de sécurité générale inclu > Coefficient côté charge utilisé = 1,4
- > Queraktion nicht an den Rand gerichtet > Generelle Sicherheitskoeffizient inbegriffen > Verwendeter Lasterhöhungssicherheitskoeffizient = 1,4



Con foro allagato, riduzione del carico consigliato del 20%  
With flooded hole, reduction of the recommended load of 20%

## MIN Dati di carico con profondità effettiva ancoraggio MINIMA > Load data with MINIMUM effective anchorage depth Donnes de charge avec profondeur efficace d'ancrage MINIMALE > Lastdaten mit MINIMALER effektiven Verankerungstiefe

MATERIALE MATERIAL	DIAMETRO BARRA ROD DIAMETER	PROFONDITÀ EFF. ANCORAGGIO EFFECTIVE ANCHORAGE DEPTH	CARICO ULTIMO MEDIO A TRAZIONE	CARICO ULTIMO MEDIO A TAGLIO	CARICO CARATTERISTICO A TRAZIONE	CARICO CARATTERISTICO A TAGLIO	CARICO AMMISSIBILE A TRAZIONE	CARICO AMMISSIBILE A TAGLIO
			ULTIMATE TENSION LOAD	ULTIMATE SHEAR LOAD	CHARACTERISTIC TENSILE LOAD	CHARACTERISTIC SHEAR LOAD	ADMISSIBLE TENSILE LOAD	ADMISSIBLE SHEAR LOAD
	d [mm]	$h_{ef MIN}$ [mm]	$N_{rum}$ [kN]	$V_{rum}$ [kN]	$N_{rk}$ [kN]	$V_{rk}$ [kN]	$N_{rec}$ [kN]	$V_{rec}$ [kN]
C20/25 Calcestruzzo non fessurato Non cracked Concrete Beton non fissuré Ungerissener Beton	Ø8	60	21,6	16,2	18,2	13,5	8,7	7,7
	Ø10	60	27,0	25,4	22,8	21,2	10,8	12,1
	Ø12	70	37,9	36,6	29,5	30,5	14,0	17,4
	Ø14	80	48,3	49,8	36,1	41,5	17,2	23,7
	Ø16	80	48,3	65,1	36,1	54,2	17,2	31,0
	Ø20	90	57,6	101,7	43,1	84,8	20,5	41,0
	Ø25	100	67,5	135,0	50,5	101,0	24,0	48,1
	Ø28	112	80,0	160,0	59,8	119,7	28,5	57,0
	Ø32	128	97,7	195,5	73,1	146,2	34,8	69,6



## MED Dati di carico con profondità effettiva ancoraggio MEDIA > Load data with MEDIUM effective anchorage depth Donnes de charge avec profondeur efficace d'ancrage MOYENNE > Lastdaten mit MITTLERER effektiven Verankerungstiefe

MATERIALE MATERIAL	DIAMETRO BARRA ROD DIAMETER	PROFONDITÀ EFF. ANCORAGGIO EFFECTIVE ANCHORAGE DEPTH	CARICO ULTIMO MEDIO A TRAZIONE	CARICO ULTIMO MEDIO A TAGLIO	CARICO CARATTERISTICO A TRAZIONE	CARICO CARATTERISTICO A TAGLIO	CARICO AMMISSIBILE A TRAZIONE	CARICO AMMISSIBILE A TAGLIO
			ULTIMATE TENSION LOAD	ULTIMATE SHEAR LOAD	CHARACTERISTIC TENSILE LOAD	CHARACTERISTIC SHEAR LOAD	ADMISSIBLE TENSILE LOAD	ADMISSIBLE SHEAR LOAD
	d [mm]	$h_{ef MED}$ [mm]	$N_{rum}$ [kN]	$V_{rum}$ [kN]	$N_{rk}$ [kN]	$V_{rk}$ [kN]	$N_{rec}$ [kN]	$V_{rec}$ [kN]
C20/25 Calcestruzzo non fessurato Non cracked Concrete Beton non fissuré Ungerissener Beton	Ø8	80	27,1	16,2	24,3	13,5	11,6	7,7
	Ø10	90	40,6	25,4	34,2	21,2	16,3	12,1
	Ø12	110	59,5	36,6	50,2	30,5	23,9	17,4
	Ø14	125	77,1	49,8	63,4	41,5	30,1	23,7
	Ø16	140	96,4	65,1	78,8	54,2	37,5	31,0
	Ø20	170	139,1	101,7	109,8	84,8	52,3	48,4
	Ø25	210	201,0	159,0	150,8	132,5	71,8	75,7
	Ø28	270	260,8	199,5	179,1	166,2	85,3	95,0
	Ø32	300	282,7	260,5	260,5	217,1	92,4	124,0



## MAX Dati di carico con profondità effettiva ancoraggio MASSIMO > Load data with MAXIMUM effective anchorage depth Donnes de charge avec profondeur efficace d'ancrage MAXIMUM > Lastdaten mit MAXIMALER effektiven Verankerungstiefe

MATERIALE MATERIAL	DIAMETRO BARRA ROD DIAMETER	PROFONDITÀ EFF. ANCORAGGIO EFFECTIVE ANCHORAGE DEPTH	CARICO ULTIMO MEDIO A TRAZIONE	CARICO ULTIMO MEDIO A TAGLIO	CARICO CARATTERISTICO A TRAZIONE	CARICO CARATTERISTICO A TAGLIO	CARICO AMMISSIBILE A TRAZIONE	CARICO AMMISSIBILE A TAGLIO
			ULTIMATE TENSION LOAD	ULTIMATE SHEAR LOAD	CHARACTERISTIC TENSILE LOAD	CHARACTERISTIC SHEAR LOAD	ADMISSIBLE TENSILE LOAD	ADMISSIBLE SHEAR LOAD
	d [mm]	$h_{ef MAX}$ [mm]	$N_{rum}$ [kN]	$V_{rum}$ [kN]	$N_{rk}$ [kN]	$V_{rk}$ [kN]	$N_{rec}$ [kN]	$V_{rec}$ [kN]
C20/25 Calcestruzzo non fessurato Non cracked Concrete Beton non fissuré Ungerissener Beton	Ø8	160	27,1	16,2	27,1	13,5	12,9	7,7
	Ø10	200	42,4	25,4	42,4	21,2	20,2	12,1
	Ø12	240	61,0	36,6	61,0	30,5	29,0	17,4
	Ø14	280	83,1	49,8	83,1	41,5	39,5	23,7
	Ø16	320	108,5	65,1	108,5	54,2	51,7	31,0
	Ø20	400	169,6	101,7	169,6	84,8	80,7	48,4
	Ø25	500	265,0	159,0	265,0	132,5	126,2	75,7
	Ø28	560	332,5	199,5	332,5	166,2	158,3	95,0
	Ø32	640	434,2	260,5	414,3	217,1	197,3	124,0





> **Dati carico > Load data > Données de charge > Lastdaten**

<b>D</b>	$N_{Rum}$ [kN]	Carico ultimo medio a trazione > Average ultimate tension load > Charge maximum moyenne de traction Durchschnittliche maximale Zuglast
	$V_{Rum}$ [kN]	Carico ultimo medio a taglio > Average ultimate shear load > Charge maximum moyenne de cisaillement Durchschnittliche maximale Querlast
<b>E</b>	$N_{Rk}$ [kN]	Carico caratteristico a trazione > Characteristic tension load > Charge caracteristique de traction Charakteristische Zuglast
	$V_{Rk}$ [kN]	Carico caratteristico a taglio > Characteristic shear load > Charge caracteristique de cisaillement Charakteristische Querlast
<b>L</b>	$N_{rec}$ [kN]	Carico ammissibile a trazione > Admissible tensile load > Charge admissible de traction > Zulässige Zuglast
	$V_{rec}$ [kN]	Carico ammissibile a taglio > Admissible shear load > Charge admissible de cisaillement > Zulässige Querlast

- > Applicazioni in accordo alla teoria dell'ancoraggio
- > Application according to the anchors theory
- > Application en conformité avec la théorie de l'ancrage
- > Anwendung in Übereinstimmung mit der Verankerungstheorie

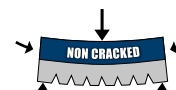

**+40°C**

- > Carichi validi per singolo ancorante senza influenza di interasse e distanza dal bordo e  $h \geq 2h_{ef}$  > 1kN = 100 Kg
- > Loads for single anchor with no influence of spacing and edge distance and with  $h \geq 2h_{ef}$
- > Charges valables pour chaque ancrage sans influence d'interaxe et distance du bord et  $h \geq 2h_{ef}$
- > Passende Ringe für den einzelnen Veranker, ohne Achsenabstandseinfluss und des Randabstands und  $h \geq 2h_{ef}$

- > Azione di taglio non diretta verso il bordo > Coefficiente di sicurezza globale incluso > Coefficiente lato carichi utilizzato = 1,4
- > Shear directed away from the edge > General safety factor included > Load increasing safety coefficient used = 1,4
- > Action de cisaillement pas dirigée vers le bord > Coefficient de sécurité generale inclu > Coefficient côté charge utilisé = 1,4
- > Queraktion nicht an den Rand gerichtet > Generelle Sicherheitskoeffizient inbegriffen > Verwendeter Lasterhöhungssicherheitskoeffizient = 1,4



Con foro allagato, riduzione del carico consigliato del 20%  
With flooded hole, reduction of the recommended load of 20%

**MIN** Dati di carico con profondità effettiva ancoraggio MINIMA > Load data with MINIMUM effective anchorage depth  
Donnes de charge avec profondeur efficace d'ancrage MINIMALE > Lastdaten mit MINIMALER effektiven Verankerungstiefe

MATERIALE MATERIAL	DIAMETRO BARRA ROD DIAMETER	PROFONDITÀ EFF. ANCORAGGIO EFFECTIVE ANCHORAGE DEPTH	CARICO ULTIMO MEDIO A TRAZIONE	CARICO ULTIMO MEDIO A TAGLIO	CARICO CARATTERISTICO A TRAZIONE	CARICO CARATTERISTICO A TAGLIO	CARICO AMMISSIBILE A TRAZIONE	CARICO AMMISSIBILE A TAGLIO
			ULTIMATE TENSION LOAD	ULTIMATE SHEAR LOAD	CHARACTERISTIC TENSILE LOAD	CHARACTERISTIC SHEAR LOAD	ADMISSIBLE TENSILE LOAD	ADMISSIBLE SHEAR LOAD
	d [mm]	$h_{ef MIN}$ [mm]	$N_{Rum}$ [kN]	$V_{Rum}$ [kN]	$N_{Rk}$ [kN]	$V_{Rk}$ [kN]	$N_{rec}$ [kN]	$V_{rec}$ [kN]
C20/25 Calcestruzzo non fessurato Non cracked Concrete Beton non fissuré Ungerissener Beton	Ø8	60	21,6	16,2	13,1	13,5	6,2	7,7
	Ø10	60	27,0	25,4	16,4	21,2	7,8	12,1
	Ø12	70	37,9	36,6	23,0	30,5	10,9	17,4
	Ø14	80	48,3	49,8	29,2	41,5	13,9	23,7
	Ø16	80	48,3	65,1	32,4	54,2	15,4	30,9
	Ø20	90	57,6	101,7	41,8	83,7	19,9	39,8
	Ø25	100	67,5	135,0	50,5	101,0	24,0	48,1
	Ø28	112	80,0	160,0	53,5	107,0	25,4	50,9
	Ø32	128	97,7	195,5	59,6	119,3	28,4	56,8



**MED** Dati di carico con profondità effettiva ancoraggio MEDIA > Load data with MEDIUM effective anchorage depth  
Donnes de charge avec profondeur efficace d'ancrage MOYENNE > Lastdaten mit MITTLERER effektiven Verankerungstiefe

MATERIALE MATERIAL	DIAMETRO BARRA ROD DIAMETER	PROFONDITÀ EFF. ANCORAGGIO EFFECTIVE ANCHORAGE DEPTH	CARICO ULTIMO MEDIO A TRAZIONE	CARICO ULTIMO MEDIO A TAGLIO	CARICO CARATTERISTICO A TRAZIONE	CARICO CARATTERISTICO A TAGLIO	CARICO AMMISSIBILE A TRAZIONE	CARICO AMMISSIBILE A TAGLIO
			ULTIMATE TENSION LOAD	ULTIMATE SHEAR LOAD	CHARACTERISTIC TENSILE LOAD	CHARACTERISTIC SHEAR LOAD	ADMISSIBLE TENSILE LOAD	ADMISSIBLE SHEAR LOAD
	d [mm]	$h_{ef MED}$ [mm]	$N_{Rum}$ [kN]	$V_{Rum}$ [kN]	$N_{Rk}$ [kN]	$V_{Rk}$ [kN]	$N_{rec}$ [kN]	$V_{rec}$ [kN]
C20/25 Calcestruzzo non fessurato Non cracked Concrete Beton non fissuré Ungerissener Beton	Ø8	80	27,1	16,2	17,5	13,5	8,3	7,7
	Ø10	90	40,6	25,4	24,6	21,2	11,7	12,1
	Ø12	110	59,5	36,6	36,1	30,5	17,2	17,4
	Ø14	125	77,1	49,8	45,6	41,5	21,7	23,7
	Ø16	140	96,4	65,1	56,7	54,2	27,0	31,0
	Ø20	170	139,1	101,7	79,1	84,8	37,6	48,4
	Ø25	210	201,0	159,0	108,6	132,5	51,7	75,7
	Ø28	270	260,8	199,5	129,0	166,2	61,4	95,0
	Ø32	300	282,7	260,5	139,8	217,1	66,6	124,0



**MAX** Dati di carico con profondità effettiva ancoraggio MASSIMO > Load data with MAXIMUM effective anchorage depth  
Donnes de charge avec profondeur efficace d'ancrage MAXIMUM > Lastdaten mit MAXIMALER effektiven Verankerungstiefe

MATERIALE MATERIAL	DIAMETRO BARRA ROD DIAMETER	PROFONDITÀ EFF. ANCORAGGIO EFFECTIVE ANCHORAGE DEPTH	CARICO ULTIMO MEDIO A TRAZIONE	CARICO ULTIMO MEDIO A TAGLIO	CARICO CARATTERISTICO A TRAZIONE	CARICO CARATTERISTICO A TAGLIO	CARICO AMMISSIBILE A TRAZIONE	CARICO AMMISSIBILE A TAGLIO
			ULTIMATE TENSION LOAD	ULTIMATE SHEAR LOAD	CHARACTERISTIC TENSILE LOAD	CHARACTERISTIC SHEAR LOAD	ADMISSIBLE TENSILE LOAD	ADMISSIBLE SHEAR LOAD
	d [mm]	$h_{ef MAX}$ [mm]	$N_{Rum}$ [kN]	$V_{Rum}$ [kN]	$N_{Rk}$ [kN]	$V_{Rk}$ [kN]	$N_{rec}$ [kN]	$V_{rec}$ [kN]
C20/25 Calcestruzzo non fessurato Non cracked Concrete Beton non fissuré Ungerissener Beton	Ø8	160	27,1	16,2	27,1	13,5	12,9	7,7
	Ø10	200	42,4	25,4	42,4	21,2	20,2	12,1
	Ø12	240	61,0	36,6	61,0	30,5	29,0	17,4
	Ø14	280	83,1	49,8	83,1	41,5	39,5	23,7
	Ø16	320	108,5	65,1	108,5	54,2	51,7	31,0
	Ø20	400	169,6	101,7	169,6	84,8	80,7	48,4
	Ø25	500	265,0	159,0	258,6	132,5	123,1	75,7
	Ø28	560	332,5	199,5	267,5	166,2	127,4	95,0
	Ø32	640	434,2	260,5	298,3	217,1	142,0	124,0





**SCHEDA TECNICA  
TECHNICAL DATA SHEET  
FICHE TECHNIQUE  
TECHNISCHES DATENBLATT**

# WINTER V-PLUS

Prodotto per uso strutturale in accordo al D.M. 14/01/2008



Opzione > Option 1  
M10 ... M20  
Opzione > Option 7  
M8 ... M24

Ø 8 ... 32 mm



Temperatura materiale base -20°C  
Base material temperature -20°C  
Temperature material de base -20°C  
Grundmaterial-temperatur -20°C



## BCR-400 V-PLUS WINTER

Cartuccia coassiale  
Coaxial cartridge  
Cartouche coaxiale  
Koaxialkartusche  
400 ml  
cod. 747274



**STOCCAGGIO E CONSERVAZIONE**  
STORAGE AND CONSERVATION  
STOCKAGE ET CONSERVATION  
LAGERUNG UND AUFBEWAHRUNG

+30°C  
+5°C

**CARTUCCIA**  
CARTRIDGE  
CARTOUCHE  
KARTUSCHE

**STOP 12**

**DURATA (mesi)**  
EXPIRY (months)  
ECHANCHE (mois)  
HALTBARKEIT (Monate)

PER CARATTERISTICHE, DATI TECNICI E DI CARICO, VEDERE BCR V-PLUS  
FOR CHARACTERISTICS, TECHNICAL AND LOAD DATA, SEE BCR V-PLUS  
POUR CARACTÉRISTIQUES, DONNÉES TECHNIQUES ET DE CHARGE, VOIR BCR V-PLUS  
FÜR EIGENSCHAFTEN, TECHNISCHE ANGABEN UND LASTDATEN, SIEHE BCR V-PLUS

### > Gamma prodotti > Product's range > Gamme produits > Warenangebot

V-PLUS WINTER	CODICE > CODE NUMBER	ARTICOLO > ITEM TYPE > ARTIKEL	DESCRIZIONE > DESCRIPTION DESCRIPTION > BESCHREIBUNG	Nr.
12x	747591	WINTER/TROPICAL OSR 400 WINTER SECCHIO	12 x cartucce, 1 x pompa, 24 x mixers 12 x cartridges, 1 x gun, 24 x mixers	1
12x	747592	OSR 400 WINTER SECCHIO NP-2M	12 x cartouches, 24 x mixers 12 x Kartuschen, 24 x Mischer	1
20x	747593	BOX 400 WINTER	20 x cartucce, 40 x mixers > 20 x cartridges, 40 x mixers 20 x cartouches, 40 x mixers > 20 x Kartuschen, 40 x Mischer	1



**TEMPI DI POSA**  
SETTING TIMES  
TEMPS D'INSTALLATION  
VERLEGUNGSZEIT

**+5°C**

Temperatura minima del prodotto per l'applicazione  
Minimum product temperature for application  
Température minimal de la cartouche pour l'application  
Min Kartouchetemperatur für die Anwendung

Per foro allagato e umido, raddoppiare il tempo di messa in carico  
For wet and flooded hole, double curing time  
Pour trou inondé et humide, doubler les temps avant l'application de charge  
Doppel Bauzeit mit nassembeton und mit Wasser gefüllten Bhorlöchern

01	02	03
20°C	5 min	30 min
15°C	7 min	35 min
10°C	10 min	50 min
5°C	15 min	1 h 10'
0°C	25 min	1 h 40'
-5°C	40 min	3 h 30'
-10°C	1 hour	10 hours
-15°C	1h 30'	17 hours
-20°C	2 hours	24 hours

**ASCIUTTO**  
DRY  
SEC  
TROCKENEM

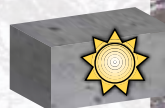

- 01 Temperatura supporto > Base material temperature > Temperature material de base > Grundmaterial-temperatur
- 02 Tempo di lavorabilità > Open time > Temps de manipulation > Verarbeitungszeit
- 03 Attesa per la messa in carico > Curing time > Temps avant l'application de charge > Bauzeit





# TROPICAL V-PLUS

Prodotto per uso strutturale in accordo al D.M. 14/01/2008

ETAG 001 Part 5 OPTION 1 ETA - 09/0140	ETAG 001 TR023 ETA-09/0246
Opzione > Option 1	Ø 8 ... 32 mm
M10 ... M20	
Opzione > Option 7	
M8 ... M24	



Temperatura materiale base +50°C  
Base material temperature +50°C  
Temperature material de base +50°C  
Grundmaterial-temperatur +50°C



**STOCCAGGIO E CONSERVAZIONE**  
STORAGE AND CONSERVATION  
STOCKAGE ET CONSERVATION  
LAGERUNG UND AUFBEWAHRUNG

+30°C  
+5°C

**CARTUCCIA**  
CARTRIDGE  
CARTOUCHE  
KARTUSCHE

**DURATA (mesi)**  
EXPIRY (months)  
ECHEANCHE (mois)  
HALTBARKEIT (Monate)

## BCR-400 (\*) V-PLUS TROPICAL

Cartuccia coassiale  
Coaxial cartridge  
Cartouche coaxiale  
Koaxialkartusche  
400 ml  
**747276**



PER CARATTERISTICHE, DATI TECNICI E DI CARICO, VEDERE BCR V-PLUS  
FOR CHARACTERISTICS, TECHNICAL AND LOAD DATA, SEE BCR V-PLUS  
POUR CARACTÉRISTIQUES, DONNÉES TECHNIQUES ET DE CHARGE, VOIR BCR V-PLUS  
FÜR EIGENSCHAFTEN, TECHNISCHE ANGABEN UND LASTDATEN, SIEHE BCR V-PLUS

### > Gamma prodotti > Product's range > Gamme produits > Warenangebot

V-PLUS TROPICAL	CODICE CODE	ARTICOLO ITEM	DESCRIZIONE > DESCRIPTION DESCRIPTION > BESCHREIBUNG	
				Nr.
	<b>747276 (*)</b>	<b>BCR 400 V-PLUS TROPICAL</b>	Cartuccia da > Cartridge of > Cartouche de > Kartusche von 400 ml	12

(\*) PRODOTTO SU RICHIESTA, ORDINI PROGRAMMATI LEGATI A QUANTITÀ MINIME  
ON DEMAND PRODUCT; ORDER PLANNING REQUIRED IN CONNECTION WITH SPECIFIC QUANTITIES.  
PRODUIT SUR REQUÊTE; PLANIFICATION DES COMMANDE NÉCESSAIRE DANS LE CADRE DE QUANTITÉS SPÉCIFIQUES  
ON DEMAND-PRODUKT; AUFTRAGSPLANUNG ERFORDERLICH IN VERBINDUNG MIT SPEZIFISCHEN MENGEN.

**TEMPI DI POSA**  
SETTING TIMES  
TEMPS D'INSTALLATION  
VERLEGUNGSZEIT

**+30°C**  
Temperatura massima del prodotto per l'applicazione  
Maximum product temperature for application  
Température maximale de la cartouche pour l'application  
Max Kartouchetemperatur für die Anwendung

Per foro allagato e umido, raddoppiare il tempo di messa in carico  
For wet and flooded hole, double curing time  
Pour trou inondé et humide, doublés les temps avant l'application de charge  
Doppel Bauzeit mit nassembeton und mit Wasser gefüllten Bhorlöchern

01	02	03
°C		Kg
50°C	3 min	20 min
45°C	3 min	20 min
40°C	4 min	20 min
35°C	6 min	30 min
30°C	8 min	40 min
25°C	11 min	50 min
20°C	14 min	1 hour



- 01 Temperatura supporto > Base material temperature > Temperature material de base > Grundmaterial-temperatur
- 02 Tempo di lavorabilità > Open time > Temps de manipulation > Verarbeitungszeit
- 03 Attesa per la messa in carico > Curing time > Temps avant l'application de charge > Bauzeit



# SCHEDA TECNICA TECHNICAL DATA SHEET FICHE TECHNIQUE TECHNISCHES DATENBLATT

## > Procedura di installazione > Installation procedure > Procédure d'installation > Installationsverfahren

01

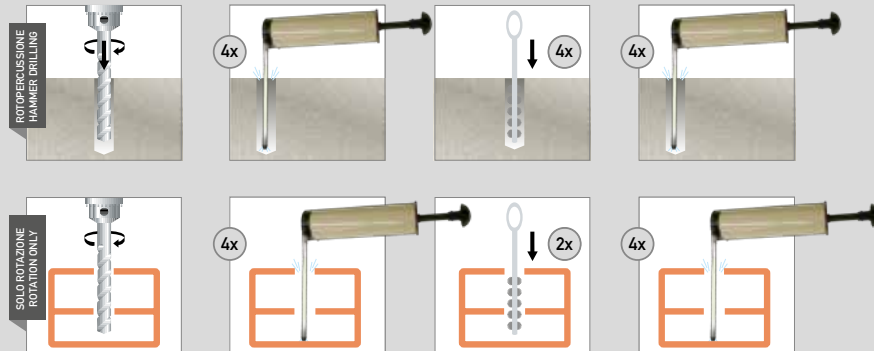

- > Eseguire il foro controllandone la perpendicolarità. Soffiare il foro con apposita pompa soffiante (o aria compressa), eseguire operazione di pulizia della superficie laterale del foro con apposito scovolino metallico, soffiare nuovamente il foro fino a che non fuoriesca più polvere e/o altro materiale residuo. Si raccomanda un'attenta pulizia della superficie laterale del foro con scovolino metallico.
- > Drill the hole and check its perpendicularity. Blow the hole with an appropriate pump blower (or compression air), clean the lateral surface of the hole with an appropriate steel brush, blow again in the hole until there is no dust and/or any residual material inside. We strongly recommend use of the steel brush to clean hole sides.

- > Réaliser le trou en contrôlant la perpendicularité. Souffler dans le trou avec la pompe soufflante prévue (ou de l'air comprimé), effectuer l'opération de nettoyage de la surface latérale du trou avec un écouvillon métallique, souffler à nouveau dans le trou jusqu'à ce qu'il n'en sorte plus de poussière et/ou d'autres matières résiduelles. Nous recommandons l'utilisation d'écouvillon métallique pour le nettoyage de la surface latérale du trou.
- > Stellen Sie die BOHRLOCHUNG unter Kontrolle der Rechtwinkigkeit her. Blasen Sie die BOHRLOCHUNG mit einer entsprechenden Pumpe (oder Druckluft) durch, nehmen Sie eine Reinigung der seitlichen Oberflächen der BOHRLOCHUNG mit einer Bürste von Metall vor, blasen Sie die BOHRLOCHUNG erneut durch, bis kein Pulver und / oder andere Materialrückstände mehr austreten. Insbesondere ist die Benutzung der Metallbürste für die Reinigung der seitlichen Oberfläche der BOHRLOCHUNG notwendig.

02

BCR 300  
BCR 165



- > Svitare il tappo, avvitare il miscelatore e inserire la cartuccia nella pompa usando protezioni per mani e viso. Nei formati 300 ml e 165 ml svitare il tappo, estrarre la clip metallica secondo le seguenti operazioni:
  - inserire il miscelatore nell'asola dell'estrattore in plastica,
  - tirare l'estrattore per sfilare la clip metallica di chiusura del sacchetto.
 Dopodiché avvitare il miscelatore, inserire la cartuccia nella pompa usando protezioni per mani e viso.
- > Unscrew the front cup, screw on the mixer and insert the cartridge in the gun. Use protections for hands and face. With the size 300 ml and 165 ml, unscrew the front cup, pull-out the steel closing clip according to the following operations:
  - insert the mixer in the eye of the plastic extractor,
  - pull the extractor to unhook the steel closing clip of the foil.
 After that, screw on the mixer and insert the cartridge in the gun. Use protections for hands and face.

- > Dévisser le bouchon, visser le mélangeur et insérer la cartouche dans la pompe en utilisant les protections pour les mains et le visage. Pour les formats 300 ml et 165 ml, dévisser le bouchon, extraire le clip métallique selon les opérations suivantes:
  - insérer le mélangeur dans la fente de l'extracteur en plastique,
  - tirer l'extracteur pour défaire le clip métallique de fermeture du sachet.
 Après cela, visser le mélangeur, insérer la cartouche dans la pompe en utilisant les protections pour les mains et le visage.
- > Lösen Sie den Verschluss, schrauben Sie den Mischer an und bringen Sie den Einsatz in der Pumpe unter Verwendung von Schutzmitteln für Hände und Gesicht an. Lösen Sie bei den Formaten zu 300 ml und 165 ml den Verschluss und ziehen Sie die Metallklemme entsprechend folgender Vorgehensweise heraus:
  - fügen Sie den Mischer in das Langloch der Ausziehvorrichtung aus Kunststoff ein,
  - Ziehen Sie die Ausziehvorrichtung heraus, um die Metallklemme zum Verschließen des Beutels zu entfernen.
 Schrauben Sie dann den Mischer fest und fügen Sie den Einsatz in die Pumpe unter Verwendung von Schutzmitteln für Hände und Gesicht ein.



03



- > Estrudere una prima parte del prodotto assicurandosi che:
  - attraverso il mixer (trasparente) il flusso di prodotto sia composto dalla parte A (colore bianco) e dalla parte B (colore nero).
  - i due componenti si siano completamente miscelati.

La completa miscelazione è raggiunta quando dal miscelatore il prodotto, ottenuto dall'unione dei due componenti, fuoriesce con colore uniforme. Solo allora la cartuccia è pronta per l'uso.
- > Before starting to use the cartridge, eject a first part of the product, being sure that:
  - Through the mixer (transparent) see that the flux of product is compound of the part A (white colour) end of part B (black colour).
  - the two components are completely mixed.

The complete mixing is reached only after that the product, obtained by mixing the two component, comes out from the mixer with an uniform colour. Now the cartridge is ready to be used.

- > Extruder une première partie du produit en s'assurant que:
  - travers le mélangeur (transparent) le flux de produit est composé par les composants A (blanc) et B (noir)
  - les deux composants soient complètement mélangés.

Le mélange complet est atteint quand le produit obtenu par l'union des deux composants sort du mélangeur avec une couleur uniforme. Alors seulement, la cartouche est prête à l'emploi.
- > Ziehen Sie einen ersten Teil des Produktes heraus und prüfen Sie dass:
  - Durch den Mischer (transparent) ist der Fluss des Produktes aus Teil A (weiße Farbe) und Teil B (schwarze Farbe) zusammengesetzt.
  - Die zwei Teilen werden völlig gemischt.

Die komplette Mischung erfolgt als vom Mischer das Produkt, sich ergebend von den zwei Teilen, mit gleichmäßiger Farbe entweicht. Da ist die Kartusche fertig für die Anwendung.

04

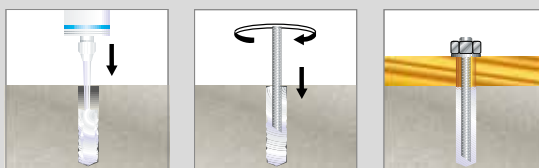

- > 1) Estrudere la resina nel foro fino a riempirlo per 2/3. In caso di materiale forato inserire la gabbietta di plastica e poi estrudere nella gabbietta. 2) Utilizzare una barra filettata tagliata a 45° nell'estremità verso il foro. Prima di inserire la barra verificare che la superficie della stessa sia asciutta, priva di olio ed altri agenti contaminanti. Inserire la barra con un movimento rotatorio per la fuoriuscita delle bolle d'aria. 3) Per l'installazione della barra e la successiva messa in carico rispettare i relativi tempi di posa specificati sia nella scheda tecnica che sull'etichetta del prodotto. 4) Prima della messa in carico verificare l'indurimento del prodotto. 5) La cartuccia può essere riutilizzata successivamente sostituendo il mixer con uno nuovo. Ricordarsi sempre di estrarre una parte del prodotto vedi punto 3.
- > 1) Inject resin into the hole up to fill it 2/3rds. In hollow bricks use the plastic sleeve and inject the resin inside. 2) Use a threaded stud with 45° cut in the side to the hole. Before insert the rod, verify that the element is dry and free oil and other contaminants. Insert threaded stud turning back and forth to avoid presence of air in the fitted hole. 3) For the installation and the following anchor load phase, respect the open time and curing time detailed in the technical data sheet and in the label of the product. 4) Before to load the anchor, check the hardened of the product. 5) The cartridge can be used again screwing the cup and replacing the mixer. Remember to eject a first part of the product, see point 3.

- > 1) Extruder la résine dans le trou jusqu'à le remplir aux 2/3. En cas de matériel troué, insérer la forme en plastique et ensuite extruder dans la forme. 2) Utiliser une barre FILETÉE coupée à 45° à l'extrémité côté trou. Avant d'insérer la barre, vérifier que la surface est sèche, sans rest de huile ou d'autres agents contaminants. Insérer la barre avec un mouvement de rotation pour faire sortir les bulles d'air. 3) Pour l'installation de la barre et le suivant chargement de l'ancrage, respecter les temps de prise indiqués sur la fiche technique et sur la cartouche. 4) Avant de charger l'ancrage, vérifier le durcissement du produit. 5) La cartouche peut être réutilisée par la suite en remplaçant le mixer par un nouveau. Se rappeler de toujours extruder une partie du produit voir point 3.
- > 1) Pressen Sie das Harz in das BOHRLOCH bis diese zu 2/3 gefüllt ist. Bei Lochmaterialien muss der Siebhülse eingefügt und dann in die Hülse gepresst werden. 2) Verwenden Sie einen Gewindestab mit 45°-Schnitt am zur BOHRLOCHUNG zeigenden Ende. Vor dem Einstecken des Gewindestabes prüfen dass seine Fläche trocken, ohne Öl und andere verunreinigende Wirkstoffe ist. Fügen Sie den Stab mit einer Drehbewegung ein, um die Luftblasen austreten zu lassen. 3) Warten Sie die Aushärzeit und Verladungszeit ab, die im technischen Datenblatt und auf dem Etikett des Produktes angegeben sind. 4) Vor der Verladung überprüfen dass das Produkt verhärtet ist. 5) Der Einsatz kann später wiederverwendet werden, indem der Mischer durch einen neuen ersetzt wird. Vergessen Sie nicht, immer einen Teil des Produktes herauszupressen, siehe Punkt 3.

> **NOTA:** Dati tecnici, di installazione e di carico possono essere oggetto di revisione. Per una versione aggiornata consultare le schede tecniche sul sito [www.bossong.com](http://www.bossong.com) o contattare il nostro Ufficio Tecnico.

> **WARNING:** Installation and loads technical data can be modified by us. For update technical data sheet see [www.bossong.com](http://www.bossong.com) or be in contact with our Technical Office.

> **NOTE:** données techniques, d'installation et de charge peuvent être objet de révision. Pour une version mise à jour, consulter les fiches techniques dans le site internet [www.bossong.com](http://www.bossong.com) ou contacter notre Bureau Technique.

> **ANMERKUNG:** technische Daten, Installationsangaben und Lastdaten können modifiziert werden. Für die aktualisierte Version sind die technischen Blätter auf der Webseite [www.bossong.com](http://www.bossong.com) nachzuschauen, oder unser Technisches Büro soll konsultiert werden.